

Falcon® Product Selection Guide

FALCON®

A Corning Brand



official distributor

SZABO-SCANDIC HandelsgmbH
Quellenstraße 110, A-1100 Wien
T. +43(0)1 489 3961-0
F. +43(0)1 489 3961-7
mail@szabo-scandic.com
www.szabo-scandic.com



**SZABO
SCANDIC**

Table of Contents

Falcon Cultureware

Cell Culture Flasks	2
Flasks	2
Multi-Flasks	4
Flask Caps.	6
Culture Slides	7
Cell Culture Dishes.	8
Plates and Microplates	10
Cell Scrapers.	13
<i>In Vitro</i> Fertilization Plasticware	14
Corning® Primaria™ Cultureware	16
Cell Culture Inserts	18
Inserts and Companion Plates	18
24 Multiwell Insert Systems	22
96 Multiwell Insert Systems	23
Corning FluoroBlok™ Cell Culture Inserts	24
Corning FluoroBlok 24 Multiwell Insert Systems	26
Corning FluoroBlok 96 Multiwell Insert Systems	28
Laboratory Aids.	30
Microplates Key Dimensions	30
Working Volumes for Tissue Culture Vessels	32
Cell Record Worksheet.	33

Additional Falcon Labware

Bacteriological Petri Dishes	36
Cell Strainers and Containers	37
Library Storage Plates.	38

Product Ordering Information

Products may not be available in all markets. For information on Purchasing Options, Terms and Conditions of Sale, Return and Repair Policies, and Warranty/Guarantee Registration, visit www.corning.com/how-to-buy.

Falcon Pipets and Pipet Controller

Serological Pipets	40
Individually Wrapped Serological Pipets	41
Bulk-Packaged Serological Pipets	42
Aspirating Pipets.	43
Transfer Pipets	43
Pipet Controller.	44

Falcon Tubes

Round-bottom Tubes	46
Conical Tubes	48
Laboratory Aids.	50
Tube Size Identification Chart	50
Tube Chemical Resistance Chart.	51
Characteristics of Falcon Plasticware.	52
Nomogram for Computing Relative Centrifugal Force	54

Index

Catalog Number Index	55
--------------------------------	----



Falcon® Brand Products

Known the world over for the popular “Falcon Tubes”, the Falcon brand has set the standard for high quality disposable plasticware for more than 50 years. Falcon-branded liquid handling and cell culture products are designed to advance research and are used in laboratories worldwide. Manufactured from advanced bioanalytical-grade resins and extensively tested, Falcon plasticware ensures high quality and consistent, reliable results.

Committed to delivering the right product at the right time

Corning Sales and Service Representatives are specialists who have the training and knowledge to help you make the right purchasing decisions. You can be confident they'll direct you to the products that deliver the best value while meeting your research needs.

Our Sales Representatives work in close partnerships with our distributors to ensure the availability of all of our products and to keep you up-to-date on new products and technologies. They stay in touch with you and the changing requirements of your research.

Corning Scientific Support Representatives have laboratory experience and an in-depth understanding of our products and their applications. Based on their experience, they provide expert assistance in selecting the products that best meet the requirements of your research protocols.

Our Customer Service Representatives provide the information you need to place and process your orders accurately and efficiently. They make sure you get the products you need, when and where you need them, whether they are through one of our authorized distributors or directly through Corning.

Our Commitment to Quality

All Falcon® products are manufactured per current Good Manufacturing Practices (cGMP, EN ISO 13485 certified, and QSR (21 CFR 820) compliant). The ISO certification verifies our facilities meet international quality system standards. The quality system is routinely audited by a notified body to ensure a work environment that consistently maintains the highest standards. ISO compliance gives our customers an added level of assurance that Corning is committed to superior quality and continuous product improvement.

Corning facilities and the products they manufacture

Durham, North Carolina EN ISO 13485 certified and QSR (21 CFR 820) compliant

- ▶ Falcon flasks
- ▶ Falcon vented caps
- ▶ Falcon serological and aspirating pipets
- ▶ Falcon specimen containers
- ▶ Falcon cell strainers
- ▶ Falcon cell culture inserts
- ▶ Falcon cell culture dishes
- ▶ Falcon bacteriological petri dishes
- ▶ Falcon multiwell and assay plates
- ▶ Falcon *in vitro* fertilization plasticware*
- ▶ Corning® Primaria™ flasks, dishes, and plates

*Falcon IVF products are US Class II Medical device. Falcon IVF products are CE marked per EU requirements and all references to EU MDD 93/42/EEC will be updated to EU MDR 2017/745 pending approval from notified body.

Reynosa, Mexico EN ISO 13485 certified and QSR (21 CFR 820) compliant

- ▶ Falcon conical and round-bottom tubes

Corning HTL, Poland ISO 9001 certified

- ▶ Falcon pipet controller



Falcon® Cultureware

Trust Falcon, the first name in cell culture

Falcon Cultureware was the first developed tissue culture-treated plasticware that enabled scientists to grow cells *in vitro*.

Table of Contents

Cell Culture Flasks	2
Flasks	2
Multi-Flasks	4
Flask Caps	6
Culture Slides	7
Cell Culture Dishes	8
Plates and Microplates	10
Cell Scrapers	13
<i>In Vitro</i> Fertilization Plasticware	14
Corning® Primaria™ Cultureware	16
Cell Culture Inserts	18
Inserts and Companion Plates	18
24 Multiwell Insert Systems	22
96 Multiwell Insert Systems	23
Corning FluoroBlok™ Cell Culture Inserts	24
Corning FluoroBlok 24 Multiwell Insert Systems	26
Corning FluoroBlok 96 Multiwell Insert Systems	28
Laboratory Aids	30
Microplates Key Dimensions	30
Working Volumes for Tissue Culture Vessels	32
Cell Record Worksheet	33

Product Ordering Information

Products may not be available in all markets. For information on Purchasing Options, Terms and Conditions of Sale, Return and Repair Policies, and Warranty/Guarantee Registration, visit www.corning.com/how-to-buy.

Falcon® Cell Culture Flasks

- ▶ Vacuum-gas plasma tissue culture treatment provides consistent cell attachment, spreading, and growth
- ▶ Choose standard tissue culture (TC), Corning® Primaria™, or non-treated polystyrene growth surfaces to meet your individual cell culture requirements
- ▶ Secure stacking provides stability from accidental tips or spills, and protection against contamination (canted neck flasks)
- ▶ Sterilized by irradiation
- ▶ Nonpyrogenic tested to less than 0.1 EU/mL
- ▶ Volumetric graduations and writing patch
- ▶ Vented caps incorporate a 0.2 µm hydrophobic membrane to isolate the container it is placed on from the environment while allowing gas exchange and reducing spills.
- ▶ Growth area and volume are nominal

Tissue culture-friendly packaging

- ▶ Convenient reseal tab on the bag
- ▶ Innovative bag materials that will not scuff or scratch the flask's optical surface
- ▶ Double-wall bags
- ▶ Medical-style, peel-open bags assure that flask sterility is maintained
- ▶ Recyclable bag material (low density polyethylene)
- ▶ Knife not required for case opening

225 cm² Flasks

- ▶ Innovative shape permits access to all corners with a pipet or scraper
- ▶ Unique Locking Incubation Position prevents caps from falling off or closing while in the open position
- ▶ Plug Seal or vented cap available
- ▶ Skirted, canted neck adds stability to neck area of flask
- ▶ Large frosted writing area
- ▶ Vertical graduations up to 400 mL
- ▶ 100 mL maximum horizontal working volume line

Low profile 150 cm² Flasks

- ▶ Low profile for efficient stacking and incubator utilization
- ▶ Unique Locking Incubation Position prevents caps from falling off or closing while in the open position
- ▶ Precision engineered cap spins on quickly
- ▶ Innovative shape permits access to all corners with a pipet or cell scraper



Tips

- ▶ Use Falcon non-treated cell culture flasks for suspension cultures.
- ▶ For enhanced cell performance, Corning BioCoat® Flasks are available with pre-applied matrix proteins, and Corning PureCoat™ Flasks are available with synthetic coating (amine and carboxyl). For more information, visit www.corning.com/lifesciences.

Falcon® Cell Culture Flasks

Cat. No.	Volume (mL)	Growth Area (cm ²)	Surface	Neck Style	Cap Style	Qty/Pk	Qty/Cs
353018	25	12.5	TC-treated	Canted	Plug Seal	10	100
353107	25	12.5	TC-treated	Canted	Vented	10	100
353014	50	25	TC-treated	Canted	Plug Seal	20	200
353108	50	25	TC-treated	Canted	Vented	20	100
353813	50	25	Corning® Primaria™ TC-treated	Canted	Plug Seal	20	200
353808	50	25	Corning Primaria TC-treated	Canted	Vented	20	100
353082	70	25	TC-treated	Canted	Plug Seal	20	200
353109	70	25	TC-treated	Canted	Vented	20	100
353009	70	25	Non-treated	Canted	Plug Seal	20	200
353024	250	75	TC-treated	Straight	Plug Seal	5	100
353110	250	75	TC-treated	Straight	Vented	5	100
353824	250	75	Corning Primaria TC-treated	Straight	Plug Seal	5	100
353810	250	75	Corning Primaria TC-treated	Straight	Vented	5	100
353135	250	75	TC-treated	Canted	Plug Seal	5	60
353136	250	75	TC-treated	Canted	Vented	5	60
353133	250	75	Non-treated	Canted	Plug Seal	5	60
355000	600	150	TC-treated	Canted	Plug Seal	5	40
355001	600	150	TC-treated	Canted	Vented	5	40
353028	750	175	TC-treated	Straight	Plug Seal	5	40
353112	750	175	TC-treated	Straight	Vented	5	40
353139	800	225	TC-treated	Canted	Plug Seal	5	30
353138	800	225	TC-treated	Canted	Vented	5	30

Products may not be available in all markets.

Falcon® Cell Culture Multi-Flasks

Increase productivity by enabling to grow more cells faster and easier. 3- or 5-layer formats provide 525 cm² and 875 cm² cell growth surface area, respectively.

Features

- ▶ Even distribution of media across all layers for homogeneous cell growth
- ▶ Ability to mix cells and reagents in the Falcon Multi-Flask saves time and reduces risk of contamination
- ▶ Flexible design allows to pour or aspirate/recover cells using a pipet
- ▶ Consistent surface treatment for predictable scale-up
- ▶ Lot number printed on each flask for traceability
- ▶ Manufactured in compliance to QSR standards

Designed to fit your protocol

Falcon Multi-Flasks offer the same footprint and the same reagent volumes and cell seeding densities per unit area as 175 cm² flasks. With the same proven surface treatment as all other Falcon flasks, it simplifies scale up.

Improves cell culture productivity

Falcon Multi-Flasks deliver a thoughtful design that simplifies cell culture workflow by eliminating multiple steps and reducing the risk of contamination.

- ▶ Pipet access allows to aspirate to replenish media and recover cells without pouring
- ▶ The mixing port enables rapid mixing inside the vessel and allows to add cell suspension, transfection, or other reagents directly to the flask. The port also enables uniform distribution of media and cells to facilitate homogeneous cell growth on all layers.

More consistent cell growth

Falcon Multi-Flasks' even distribution of media, proven vacuum gas-plasma tissue culture surface treatment, and effective gas exchange all combine to provide an optimal cell culture environment. The result is high cell yield and a homogeneous cell population.



Compatible with your cell lines

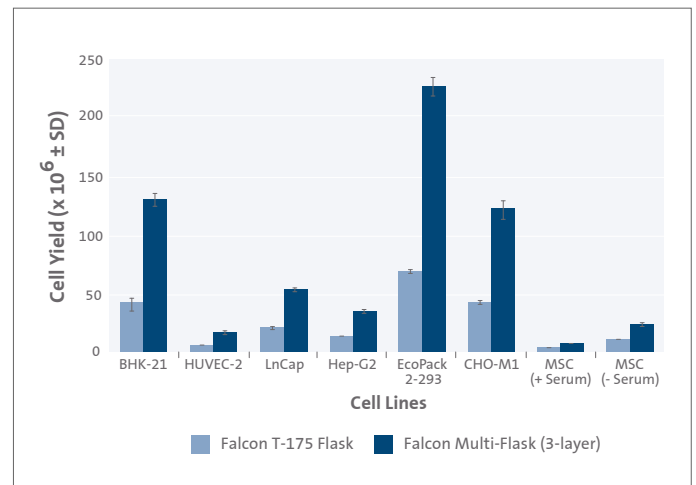

Diverse cell lines and primary cultures (with and without serum) can be grown and efficiently recovered from Falcon Multi-Flask cell culture vessels. This graph illustrates the increased cell yield one can obtain from Falcon Multi-Flasks as compared to control T-175 flasks for various cell lines.

Predictable scale-up

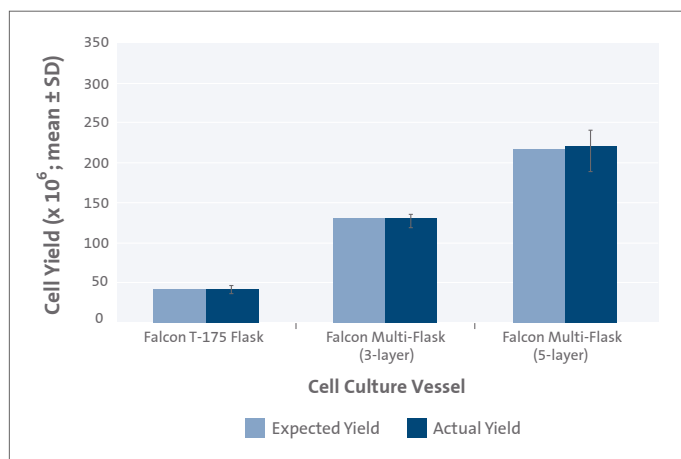

Three and five times the number of BHK-21 cells were grown and recovered from 3- and 5-layer Falcon Multi-Flasks compared to T-175 flasks. Expected yield was determined using mean cell yield from control T-175 flasks multiplied by three and five times for the 3- and 5-layer Falcon Multi-Flasks, respectively.

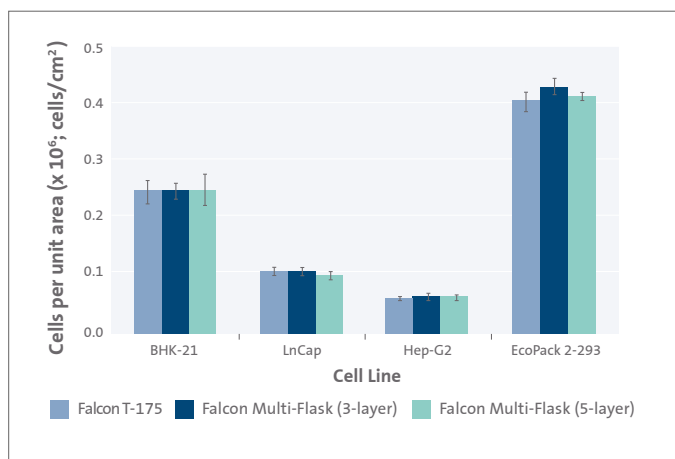

Cell yield per cm² was equivalent in 3- and 5-layer Multi-Flasks and T-175 flasks for BHK-21, LnCap, Hep-G2 and EcoPack™2-293 cells.

Consistent cell growth



This figure illustrates uniform cell growth between layers of Falcon Multi-Flasks. BHK-21 cells grown to >80% confluence in 3-layer Falcon Multi-Flasks and control T-175 flasks were fixed and stained with crystal violet. Control flasks and individual layers of the Falcon Multi-Flasks were cut and scanned.

Tips

- ▶ Contact your local Corning office for custom coating services.

Falcon® Cell Culture Multi-Flasks

Cat. No.	Description	Surface Area (cm ²)	Cap Style	Qty/Cs
353143	3-layer, TC-treated	525	Vented	12
353144	5-layer, TC-treated	875	Vented	8

Products may not be available in all markets.

Falcon® Flask Caps

A variety of caps to suit your cell culture requirements

Plug Seal caps

Falcon polyethylene plug seal caps provide a liquid-tight seal when closed and an open-incubation position for reliable gas exchange when partially opened. A reference bar on the outside of the cap is aligned with the “Falcon” on the flask for precise open-incubation conditions.

Convenient Vented Caps

- ▶ Ensure consistent gas exchange
- ▶ Polyethylene caps with an integral, hydrophobic 0.2 µm microporous membrane filter vent allow consistent gas exchange when the caps are in the closed position (see graph). Gases required for cell growth and metabolism pass freely through the vent. Falcon vented caps will not wet out.
- ▶ The vented caps prevent media that can become trapped in a partially opened cap from blocking gas exchange. The caps will not fall off in the incubator because of vibration.

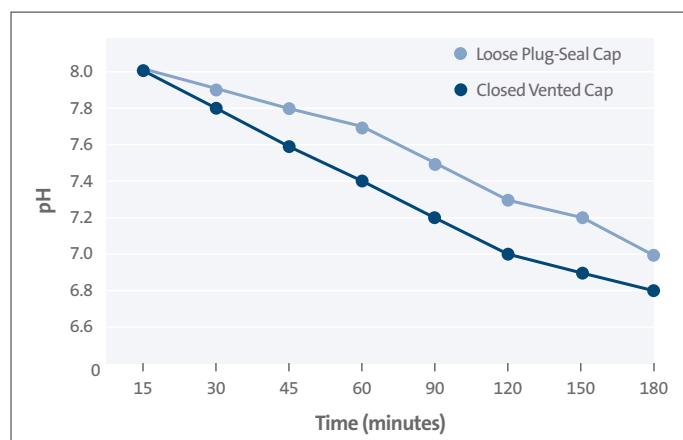
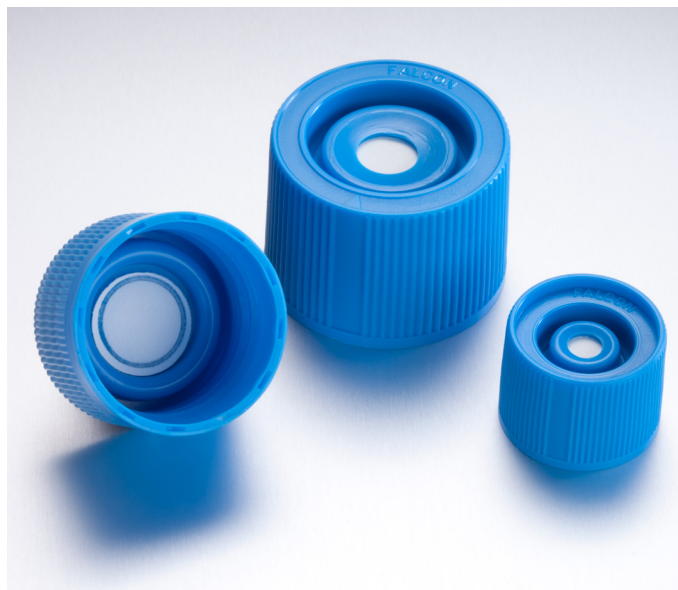

pH equilibration using vented caps after flasks are placed in an incubator (175 cm² flasks, 5% CO₂ incubator)

Falcon Flask Caps

Cat. No.	Description	Qty/Cs
354637	Vented caps for use on 25 cm ² Flasks	100
354638	Vented caps for use on 75 cm ² Flasks	100
354639	Vented caps for use on 175 cm ² Flasks	50

Products may not be available in all markets.

Tips

- ▶ Corrugated cardboard boxes are a source of particulates and associated microbial contamination and should not be kept in the tissue culture area. Corning Life Sciences has eliminated corrugated trays from most cases to reduce package waste. You can further reduce contamination due to corrugate by wiping the outside of any package or bag with alcohol or an appropriate disinfectant before putting it under the hood.

Falcon® Culture Slides

Simplified *in situ* analysis with consistent results

Falcon culture slides allow you to culture and analyze cells on a glass microscope slide. Cells are grown in a plastic chamber affixed to a specially prepared glass microscope slide and a cell culture area for growth of both adherent and non-adherent cells, as well as viral cultures. This allows you to fix and stain cells in place, without disruption of the cell monolayer. The chamber is safely removed with an easy-to-use disposable Safety Removal Tool.

Designed for ease of use and reliable results

- ▶ Simple, safe, and easy chamber removal for microscopic analysis
- ▶ Innovative sealing design
- ▶ Specially cleaned and triple-rinsed glass slides
- ▶ Performance validated with HEP-2 and BAE cells
- ▶ Tested for 72-hour confluency with MRC-5 and BAE cells

Features

- ▶ 1.2 mm beveled-edge slide, 25 x 75 mm, soda-lime glass
- ▶ Pressure-sensitive, biocompatible, non-migrating, acrylic-adhesive gasket
- ▶ Blue hydrophobic border defines cell culture areas
- ▶ Polystyrene vessel, lid, and tool
- ▶ Supplied with disposable Safety Removal Tool
- ▶ Numbered wells for easy identification
- ▶ Trays designed for use in an incubator
- ▶ Shelf life is specified on each package
- ▶ Sterile

Partial list of cells cultured on Falcon Culture Slides

- ▶ Glioblastoma
- ▶ NLBT-2 line
- ▶ HEP-2 cells
- ▶ MRC-5 cells
- ▶ Fibroblasts: human foreskin
- ▶ E6 cells infected with HSV, CMV
- ▶ FS cells infected with HSV, CMV

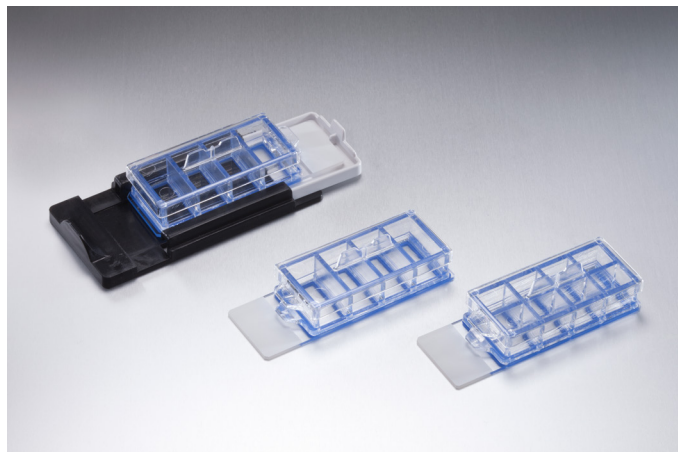

Falcon culture slides simplify vessel removal for microscopic analysis.

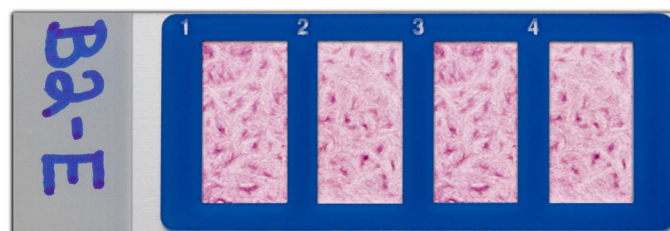

Photograph of primary bovine aortic endothelial cells grown on Falcon culture slides and stained with crystal violet. The blue hydrophobic grid defines the cell culture area. A white writing patch provides clear sample identification. Well location numbers etched in the grid are clearly visible.

Falcon Culture Slides

4-well

Cat. No.	Description	Total Volume per Well (mL)	Working Volume per Well (mL)	Qty/ Pk	Qty/ Cs
354104	1.7 cm ²	1.5-1.7	0.7-1.25	12	96
354114	1.7 cm ²	1.5-1.7	0.7-1.25	12	24

8-well

354108	0.7 cm ²	0.7-0.75	0.3-0.5	12	96
354118	0.7 cm ²	0.7-0.75	0.3-0.5	12	24

Products may not be available in all markets.

Tips

- ▶ For enhanced cell performance, Corning BioCoat® Culture Slides are available with pre-applied matrix proteins. For more information, visit www.corning.com/lifesciences

Falcon® Cell Culture Dishes

- ▶ Flat, optically clear polystyrene surfaces for distortion-free microscopic visualization of cells
- ▶ Uniform surface chemistry created by vacuum-gas plasma treatment promotes cell attachment
- ▶ Improved handling of small dishes with the unique Easy-Grip design
- ▶ Packaged in peel-open, medical-style bags
- ▶ Crystal-grade virgin polystyrene
- ▶ Standard Tissue Culture (TC treatment), Corning® Primaria™ surface treatment, and not treated polystyrene available
- ▶ Nonpyrogenic
- ▶ Sterilized by irradiation

Designed for cell culture

- ▶ Flat, distortion-free optics
- ▶ Lids designed for optimal gas exchange
- ▶ Stacking rings allow for easier stacking and handling
- ▶ Vacuum-gas plasma treatment permanently and consistently modifies the cell growth surface
- ▶ Standard tissue culture surface is hydrophilic and contains a variety of negatively charged functional groups that support cell attachment and spreading
- ▶ Corning Primaria tissue culture surface additionally incorporates nitrogen-containing functional groups and has been shown to support improved attachment, spreading, and differentiation of some cell types

Cell performance tests ensure consistent results

A sensitive clonogenic assay¹ using MRC-5 cells, a diploid human fibroblast line, is used to validate the manufacturing process for each Falcon tissue culture product. Routine testing of standard tissue culture products is performed by testing growth to confluency at 72 hours with MRC-5 cells. The surface chemistry of each lot of Corning Primaria products is confirmed by Electron Scanning for Chemical Analysis (ESCA).

Reference

1. Freshney RI, Culture of animal cells: a manual of basic technique, 2d ed., Wiley-Liss, London, p. 83 (1987).

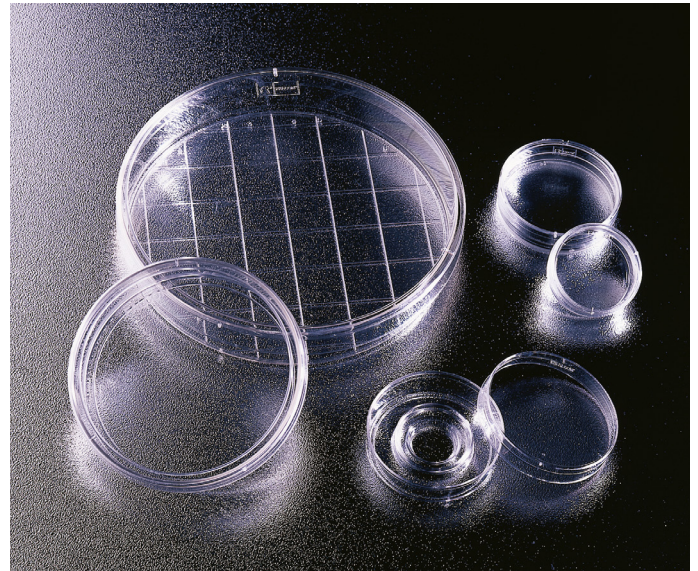

Falcon Easy-Grip Dishes. The unique design and frosted rim improve the handling of small dishes. The ability to pick up a small dish conveniently without accidentally removing the lid allows you to work faster and improves aseptic manipulation.



Tissue Culture Process Validation. Each Falcon tissue culture product is developed using a sensitive clonogenic assay¹. Shown here is a 35 mm dish with MRC-5 cells stained with crystal violet.

Falcon® Cell Culture Dishes

35 x 10 mm Easy-Grip

Cat. No.	Surface	Actual Dimensions (OD x L, mm)	Working Growth Area (cm ²)	Volume (mL)	Qty/Pk	Qty/Cs
353001	TC-treated	40.28 x 6.17	11.78	2.5-3.0	20	500
353801	Corning® Primaria® TC-treated	40.28 x 6.17	11.78	2.5-3.0	20	200

60 x 15 mm Standard*

353002	TC-treated	54.81 x 13.26	21.29	6.0-7.0	20	500
353802	Corning Primaria TC-treated	54.81 x 13.26	21.29	6.0-7.0	20	200

60 x 15 mm Easy-Grip

353004	TC-treated	52.10 x 13.13	19.5	6.0-7.0	20	500
--------	------------	---------------	------	---------	----	-----

100 x 20 mm Standard

353003	TC-treated	89.43 x 19.18	58.95	16.0-17.5	20	200
353803	Corning Primaria TC-treated	89.43 x 19.18	58.95	16.0-17.5	20	200

150 x 25 mm Gridded (20 mm grid molded in base)

353025	TC-treated	142.57 x 24.77	156.36	45.0-50.0	10	100
--------	------------	----------------	--------	-----------	----	-----

60 x 15 mm Center-well Organ Culture*

353037	TC-treated	54.84 x 13.56	2.89	-	20	500
--------	------------	---------------	------	---	----	-----

*For qualified in vitro fertilization dishes, see page 18.
Products may not be available in all markets.

Tips

- ▶ If you work with 35 mm or 60 mm dishes, try our Falcon Easy-Grip Dishes.
- ▶ Corning Life Sciences offers dishes for *in vitro* fertilization that are certified nonembryotoxic. Certification is based on a statistically relevant sample taken from each lot that is tested for embryotoxicity. See page 18 for additional information.
- ▶ Not treated polystyrene products are equivalent to bacteriological-grade polystyrene products.
- ▶ For enhanced cell performance, Corning BioCoat® Dishes are available with pre-applied matrix proteins and Corning PureCoat™ Dishes are available with synthetic coating. For more information, visit www.corning.com/lifesciences.

Related Products

- ▶ Corning Primaria Cultureware 12
- ▶ Falcon IVF Products 12
- ▶ Non-treated Dishes (bacteriological grade) 12

Falcon® Plates and Microplates

- ▶ Unique labyrinth lid, condensation rings, and deep-well design control contamination, reduce evaporation, and minimize edge effects
- ▶ Reliable vacuum-gas plasma tissue culture treatment provides well-to-well and plate-to-plate consistency

Reliable growth surfaces assure consistent cell performance

All tissue culture treatments render polystyrene hydrophilic and result in the incorporation of a variety of anionic functional groups that support cell culture. To ensure reproducible results and conditions, all Falcon tissue culture treatment is performed in a vacuum chamber.

Corning® Primaria™ tissue culture treatment additionally incorporates nitrogen-containing functional groups that have been shown to improve attachment and spreading of some cell types.

Falcon plates (non-treated) have a more hydrophobic surface and show reduced cell attachment.

Cell tests ensure consistent results

A sensitive clonogenic assay¹ using MRC-5 cells, a diploid human fibroblast line, is used to validate the manufacturing process for each Falcon and Tissue Culture (TC) product. Routine testing of standard TC products is performed by testing growth to confluency at 72 hours with MRC-5 cells. The surface chemistry of each lot of Corning Primaria products is confirmed by Electron Scanning for Chemical Analysis (ESCA).

Reference

1. Freshney RI, Culture of animal cells: a manual of basic technique, 2d ed., Wiley-Liss, London, p. 83 (1987).

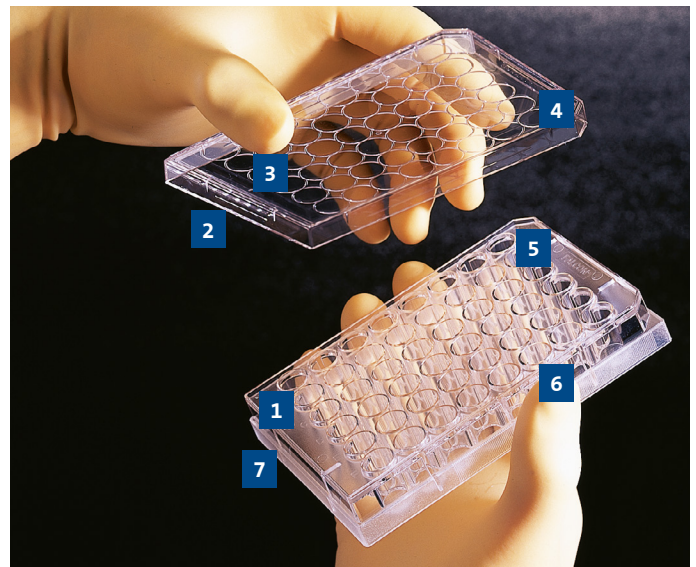

1. Alphanumeric well identification
2. One-way lid
3. Condensation rings
4. Low-evaporation labyrinth lid

5. Deep wells
6. Serrated gripping panels
7. Writing patch

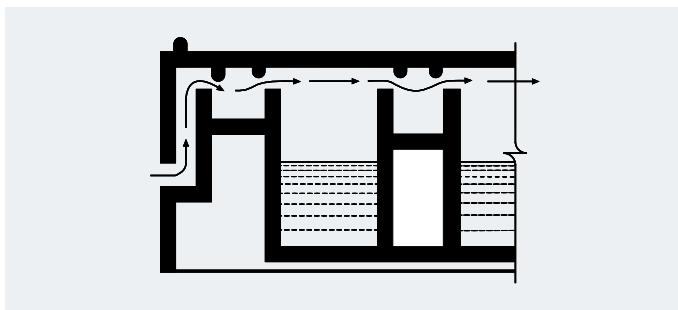

Low-Evaporation Lid. An innovative labyrinth air-passage system provides a tortuous path for gas exchange across Falcon plates. This unique feature reduces evaporation and minimizes contamination.

Falcon® Plates and Microplates

- ▶ Versatility of plate colors to suit various detection methods
- ▶ Crystal-grade virgin polystyrene
- ▶ Non-treated polystyrene, standard tissue culture (TC), and Corning® Primaria™ surface treatments available
- ▶ Convenient, peel-open medical-style packaging for individual product presentation
- ▶ Individual and Ready-Stack (RS) trays are PET (Code 1) and recyclable
- ▶ Falcon 96-, 384-, and 1536-well microplates are compatible with automation systems and meet standard ANSI/SBS footprint dimensions for microplates
- ▶ Growth area and volume are nominal – See page 36 for more details
- ▶ Nonpyrogenic
- ▶ Sterilized by irradiation

Applications

- ▶ Ion channel/Calcium flux (FLIPR)
- ▶ GPCR (Act./Inact.)
- ▶ Cell cytotoxicity
- ▶ Cell proliferation
- ▶ Cell adhesion
- ▶ Differentiation (primary cells)
- ▶ Cell migration
- ▶ Reporter gene
- ▶ Neurite outgrowth

Falcon Plates and Microplates

6-well plates, flat-bottom with lid

Cat. No.	Surface	Growth Area (cm ²)	Well Volume (mL)	Qty/Pk	Qty/Cs
353046	TC-treated	9.6	15.5	1/tray	50
353224	TC-treated	9.6	15.5	6/bag	36
353934	TC-treated	9.6	15.5	10/RS tray	60
353846	Corning Primaria TC-treated	9.6	15.5	1/tray	50
351146	Not treated	9.6	15.5	1/tray	50

12-well plates, flat-bottom with lid

353043	TC-treated	3.8	6.0	1/tray	50
353225	TC-treated	3.8	6.0	6/bag	36
351143	Not treated	3.8	6.0	1/tray	50

24-well plates, flat-bottom with lid

353047	TC-treated	1.9	3.5	1/tray	50
353226	TC-treated	1.9	3.5	6/bag	36
353935	TC-treated	1.9	3.5	10/RS tray	60
353847	Corning Primaria TC-treated	1.9	3.5	1/tray	50
351147	Not treated	1.9	3.5	1/tray	50

48-well plates, flat-bottom with lid

353078	TC-treated	0.75	1.4	1/tray	50
353230	TC-treated	0.75	1.4	6/bag	36
351178	Not treated	0.75	1.4	1/tray	50

96-well microplates, flat-bottom with lid

353072	TC-treated, clear	0.32	0.37	1/tray	50
353075	TC-treated, clear	0.32	0.37	5/bag	50
353936	TC-treated, clear	0.32	0.37	14/RS tray	84
353916	TC-treated, clear	0.32	0.37	25/bag	100
353296	TC-treated, white	0.32	0.37	5/bag	50
353376	TC-treated, black	0.32	0.37	8/bag	32
353377	TC-treated, white/clear	0.32	0.37	8/bag	32
353219	TC-treated, black/clear	0.32	0.37	8/bag	32
353872	Corning Primaria TC-treated	0.32	0.37	1/tray	50
351172	Not treated	0.32	0.37	1/tray	50

96-well microplates, U-bottom with lid (except as indicated)

353077	TC-treated	0.36	0.32	1/tray	50
353227	TC-treated	0.36	0.32	5/bag	50
351177	Not treated	0.36	0.32	1/tray	50
353910	Not treated, no lid, non-sterile	0.36	0.32	5/bag	50

Products may not be available in all markets. For 96-well microplate dimensions, see page 36.

Falcon® Microplates

- ▶ Ideal for use in high throughput systems
- ▶ Falcon 384-well microplates are compatible with automation systems and meet standard ANSI/SBS footprint dimensions for microplates

Tips

- ▶ Contact your materials management department to find out about PET recycling in your community.

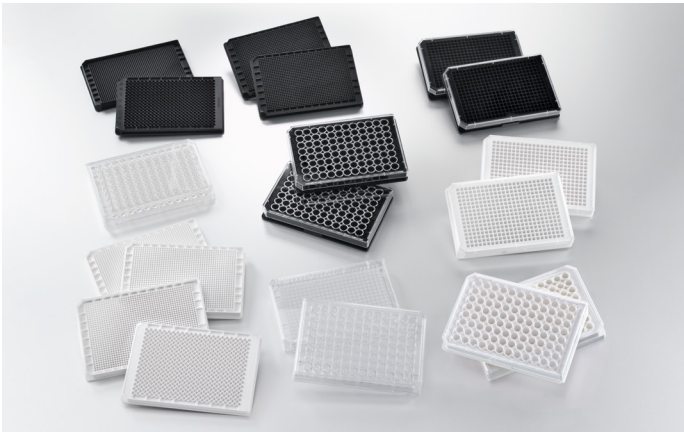

Falcon Microplates

384-well microplates, flat-bottom with lid, growth area: 10 mm², well volume: 130 µL

Cat. No.	Description	Qty/Pk	Qty/Cs
353961	TC-treated, clear	5	50
353988	TC-treated, white	5	50
353963	TC-treated, white/clear	5	50
353962	TC-treated, black/clear	5	50

Low-evaporation lids

353958	6 mm polystyrene, for 96- and 384-well microplates, non-sterile	5	50
--------	-----------------------------------------------------------------	---	----

Products may not be available in all markets. For microplate dimensions, see page 36.

Falcon® Cell Scrapers

- ▶ Falcon Cell Scrapers have been thoughtfully designed to provide maximum accessibility to the growth surfaces in a variety of culture vessels
- ▶ Cross-ribbed polystyrene handle provides greater rigidity to ensure better control while scraping cells
- ▶ Flexibility of the joint between the blade and handle improves ease of access into the neck of a flask or roller bottle
- ▶ Highly compliant thermoplastic elastomer (TPE) blade pivots to provide multiple angles to remove cells from the entire growth surface
- ▶ Available in four sizes—choose the blade and handle length to best accommodate your needs
- ▶ Supplied individually in peel-open, medical-style packaging for sterile presentation

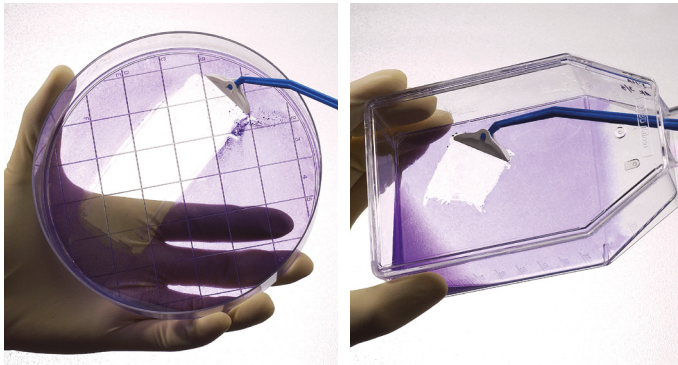

The Falcon Cell Scraper (Cat. No. 353089) has a larger blade to increase cell scraping efficiency in both Falcon Dishes and 75 cm² Flasks.

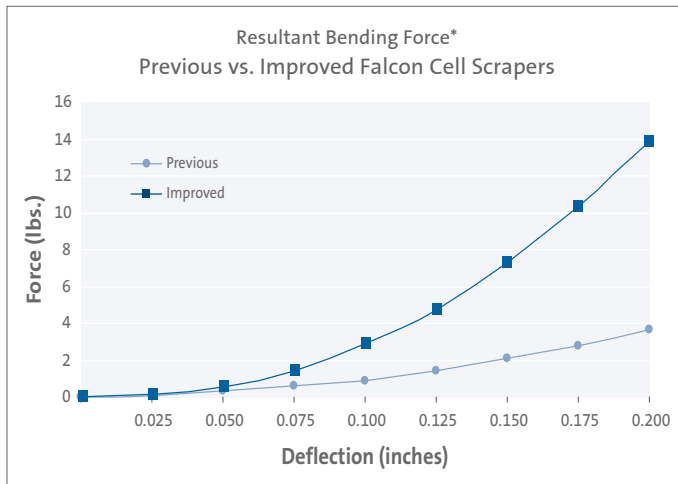

Force required to deflect a simply supported 5" portion of the handle 2.5" distal to the handle section: resultant = ('X' force) ('Y' force).

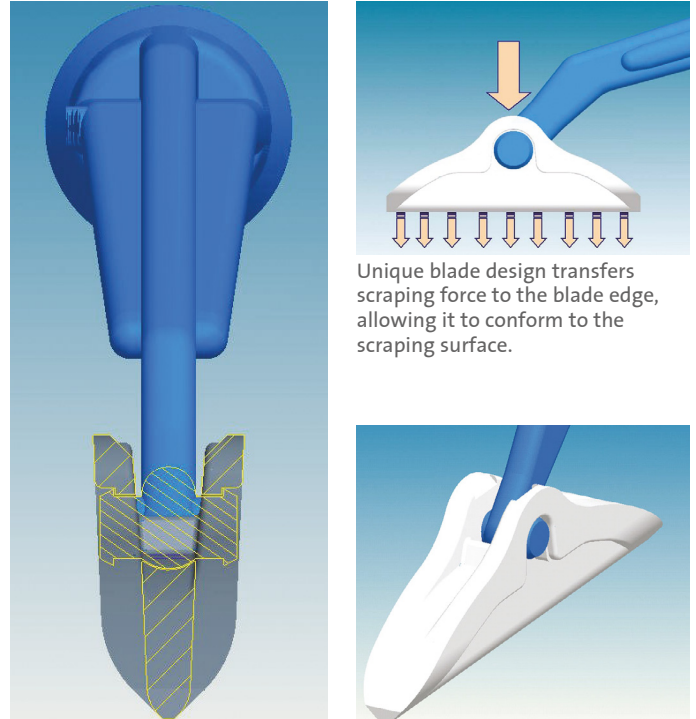
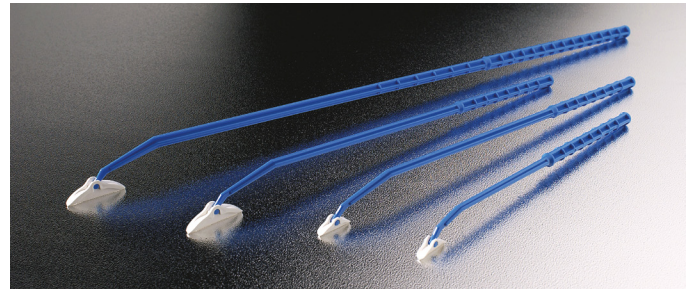

- Larger handle diameter for better gripping
- Sharper scraping edge
- More compliant blade material

"Barbs" ensure blade remains attached to handle.

Falcon Cell Scrapers

1.8 cm TPE Blade

Cat. No.	Description	Qty/Pk	Qty/Cs
353085	18 cm polystyrene handle for use with Falcon 25 cm ² flasks	1	100
353086	25 cm polystyrene handle for use with Falcon 75 cm ² flasks	1	100

3.0 cm TPE Blade

353089	25 cm polystyrene handle for use with Falcon dishes and 75 cm ² flasks	1	100
353087	40 cm polystyrene handle for use with large Falcon flasks	1	100

Products may not be available in all markets.

Falcon® *In Vitro* Fertilization Plasticware

Pre-tested Falcon IVF Products

Falcon In Vitro Fertilization (IVF) products are the first plasticware available that is sterile, nonpyrogenic, and nonembryotoxic. These pre-tested products save you time and expense in complying with the College of American Pathologists and the American Society for Reproductive Medicine recommended standards for IVF labs.

Falcon IVF products are US Class II Medical device. Falcon IVF products are CE marked per EU requirements and all references to EU MDD 93/42/EEC will be updated to EU MDR 2017/745 pending approval from notified body.

Mouse Embryo Testing

Each lot of Falcon IVF product is tested for embryotoxicity using the one-cell mouse embryo assay. Mouse embryos are isolated at the one-cell stage from B6C3F1 females following super ovulation with Gonadotropin and mating with B6D2F1 males. Falcon IVF products are tested using both a direct and indirect test assay. In the direct assay, the embryos are cultured directly in the IVF plasticware. For the indirect assay, culture media is incubated in the IVF plasticware for 24 hours at 37°C. The incubated media is then transferred to an IVF plate and the one-cell mouse embryo assay is performed. Products are deemed nonembryotoxic if they support the growth of more than 75% of the embryos to the expanded and/or hatched blastocyst stage within, or at, 96 hours.

Minimize Contamination and Evaporation

To improve manipulation of ova and embryos, an innovative four-well plate (Cat. No. 353654) was designed in conjunction with embryologists. A unique lid reduces the risk of contamination and minimizes evaporation by providing access to two wells at a time, while two remain covered. The wells are numbered, and a large writing patch allows clear sample identification. Our four-well dish (Cat. No. 353671) has a single-piece lid for easy removal. Both the four-well plate and the four-well dish are packaged in individual peel-open trays for sterile presentation.

Flat, optically clear Falcon IVF dishes and four-well plates and dishes are manufactured from virgin crystal line polystyrene that is tested for USP Class VI cytotoxicity. They have flat, optically clear surfaces for optimum manipulation and observation of ova and embryos. Lids were designed for aseptic manipulation and consistent venting to maintain humidification (except the tight-fit lid of the Falcon low-wall dish).



Features

- ▶ Sterility Assurance Level (SAL) of 10⁻⁶
- ▶ Nonembryotoxic
- ▶ Nonpyrogenic
- ▶ Noncytotoxic
- ▶ Tissue culture (TC)-treated for a consistent hydrophilic surface
- ▶ Low-wall dish is not TC-treated (not wettable) for optimal media droplet consistency
- ▶ Flat dish bottoms for distortion-free optics
- ▶ Packaged in peel-open, medical style packaging
- ▶ Multi-unit bags have resealable tabs

Falcon® Low-wall Dish

This dish has many of the same features as the other IVF products, except the dish is not TC-treated (non-wettable) for optimal media droplet consistency. The Falcon low-wall dish also makes the micro-manipulation procedure easier to perform. This product is packaged in individually sealed blister compartments so one dish can be accessed at a time, and the remaining dishes are kept protected. Procedures requiring long-term incubation are not recommended in the Falcon low-wall dish due to the tight lid fit, which results in low gas exchange rates.



Individual certificates, containing actual test results, are available for each lot at www.corning.com/resources.

Falcon In Vitro Fertilization Plasticware

Cat. No.	Description	Qty/Pk	Qty/Cs
353652	60 x 15 mm IVF round dish Well Area: 21.3 cm ² Well Volume: 23.0 mL	20	500
353653	60 x 15 mm IVF one-well dish Well Area: 2.45 cm ² Well Volume: 2.5 mL Total Volume: 20 mL	20	500
353655	50 x 9 mm IVF low-wall dish, not treated Well Area: 18.3 cm ² Wall Height: 8.6 mm	4	100
353654	17 x 11 mm IVF four-well plate Well Area: 1.4 cm ² Well Volume: 1.8 mL	1	100
353671	17 x 11 mm IVF four-well dish (one piece lid) Well Area: 1.4 cm ² Well Volume: 1.8 mL	1	100

NOTE: The lids of the Falcon IVF products are not certified nonembryotoxic. *Products may not be available in all markets.*

Corning® Primaria™ Cultureware

- ▶ Unique nitrogen-containing tissue culture surface chemistry
- ▶ Improves attachment, spreading, and growth for many primary cells or cell lines
- ▶ Crystal-grade polystyrene modified by proprietary vacuum-gas plasma treatment process
- ▶ Stable, permanent surface modification
- ▶ Optically clear
- ▶ No special storage required
- ▶ Samples from each lot of Corning Primaria products are analyzed by Electron Scanning for Chemical Analysis (ESCA)
- ▶ Packaged in red color-coded, peel-open, medical-style packages
- ▶ Nonpyrogenic tested to less than 0.1 EU/mL
- ▶ Sterilized by irradiation

Unique surface chemistry for enhanced cell culture

Consistent cell culture conditions are required for reproducible research results. In the manufacture of all cell cultureware surfaces, hydrophobic polystyrene is permanently rendered hydrophilic to support cell attachment and spreading^{1,2,3}. The consistency of this surface depends on the treatment method used.

Many manufacturers have long used atmospheric plasma treatments (i.e., corona) to create hydrophilic surfaces. In corona treatment, a high-voltage discharge creates a reactive gas plasma above the growth surface of the vessel. In this process, the highly interactive gas plasma mixture is created from ambient air. The consistency of the treatment surface can, therefore, be compromised by day-to-day environmental changes.

At Corning, molded polystyrene vessels are placed in a chamber where a partial vacuum is created. A vacuum-gas plasma treatment is fed into the chamber to create a number of negatively charged functional groups on the surface of the polystyrene vessels. The enclosed, highly controlled environment prevents contamination from the ambient air, ensuring a pure and consistent treatment surface.

A major research investment resulted in the development of this unique vacuum-gas plasma process used to produce both Corning Primaria and traditional tissue culture (TC) surfaces on Falcon® dishes, flasks, and plates. The gases used to manufacture Corning Primaria contain both oxygen and ammonia, resulting in the incorporation in the surface of a variety of nitrogen-containing functional groups in addition to the negatively charged oxygen-containing groups found on traditional TC surfaces.

The incorporation of nitrogen-containing cations has been correlated to attachment and spreading of primary endothelial cells in a clonal cell-growth assay⁴. The complex surface on Corning Primaria cultureware is homogeneous and stable and has been in use by researchers for over two decades to improve attachment and differentiation of a variety of cell types. For example, cell biologists have used Corning Primaria for cultivating hepatocytes^{5,6}, neuronal cells⁷, and other endothelial cells⁸.

The surface chemistry of Corning Primaria products is confirmed by Electron Scanning for Chemical Analysis (ESCA).

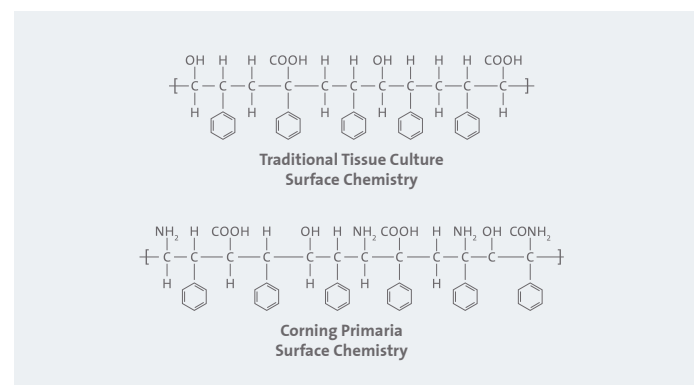

NOTE: At pH 7, carboxy groups may be slightly dissociated and assume a negative (anionic) charge. Amine groups may protonate and assume a positive charge (cationic).

A partial list of cell types cultured on Corning Primaria Cultureware

- ▶ Hepatocytes^{5,6,9,18}
- ▶ Transfected COS-7¹⁰
- ▶ Transfected HEK-293¹²
- ▶ CHO¹³
- ▶ Primary Cardiac Myocytes¹⁵
- ▶ Primary SMC¹⁴ and Skeletal Muscle Cells¹⁶
- ▶ Osteoblasts¹⁷
- ▶ Neuronal Cells⁷
- ▶ Endothelial Cells⁸

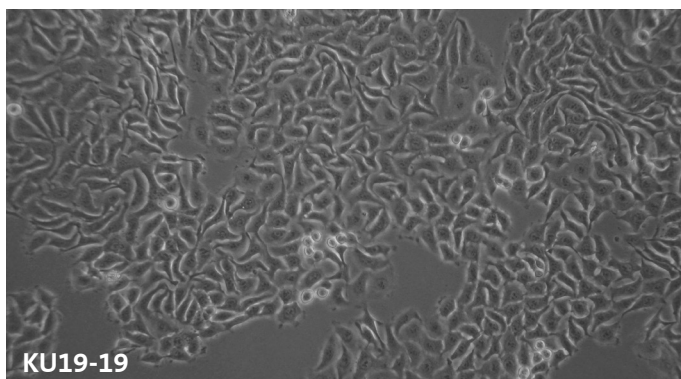

KU19-19

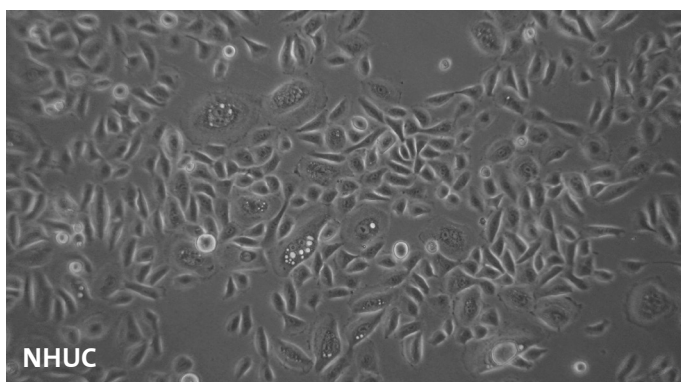

NHUC

Epithelial bladder cancer cells (KU19-19), and normal human urothelial cells (NHUC) cultured for 4 days on Corning Primaria 6-well plates (353846). Magnification 100X. Micrographs courtesy of Cancer Research UK laboratories at St James University Hospital, Leeds.

References

- Ertel S, et al. Endothelial cell growth on oxygen-containing films deposited by the radio-frequency plasmas: the role of surface carbonyl groups. *Biomater. Sci.: Polym. Ed.* 3:163 (1991).
- Curtis ASG, et al. Substrate hydroxylation and cell adhesion. *J. Cell Sci.* 86:9 (1986).
- Ramsey WS, et al. Surface treatments and cell attachment. *In Vitro* 20:802 (1984).
- Chilkoti A, et al. Investigating the relationship between surface chemistry and endothelial cell growth: partial least-squares regression of the static secondary ion mass spectra of oxygen-containing plasma-deposited films. *Analytical Chemistry* 67:2883 (1995).
- Boisclair YR, et al. Role of the Suppressor of Cytokine Signaling-3 in the Mediating the Inhibitory Effects of Interleukin-1b on the Growth Hormone-dependent Transcription of the Acid-labile Subunit Gene in Liver Cells. *J. Biol. Chem.* 275(6):3841 (2000).
- Braun JR, et al. The Major Subunit of the Asialoglycoprotein Receptor Is Expressed on the Hepatocellular Surface in Mice Lacking the Minor Receptor Subunit. *J. Biol. Chem.* 271(35):21160 (1996).
- Holgado-Madruga M, et al. Grb2-associated binder-1 mediates phosphatidylinositol 3-kinase activation and the promotion of cell survival by nerve growth factor. *PNAS USA* 94:12419 (1997).
- Silverman DJ, et al. Primary isolation of human umbilical vein endothelial cells on a surface-modified tissue culture dish. *BDL Monograph* (1986).
- Pawar A, et al. Unsaturated Fatty Acid Regulation of Peroxisome Proliferator-activated Receptor Activity in Rat Primary Hepatocytes. *J. Biol. Chem.* 278:(38):35931(2003).
- Eisenhaure T, et al. The Rho Guanine Nucleotide Exchange Factor Lsc Homo-oligomerizes and is Negatively Regulated through Domains in its Carboxyl Terminus That Are Absent in novel Splenic Isoforms. *J. Biol. Chem.* 278:(33):30975(2003).
- Nau G, et al. Human macrophage activation programs induced by bacterial pathogens. *PNAS* 99:1503(2002).
- Hearn M, et al. A Drosophila dopamine 2-like receptor: Molecular characterization and identification of multiple alternatively spliced variants. *PNAS* 99:14554(2002).
- Ludeman MJ, et al. Regulated Shedding of PAR1 N-terminal Exodomain from Endothelial Cells. *J. Biol. Chem.* 279(18):18592(2004).
- Zhuang D, et al. Nitric Oxide attenuates insulin-or IGF-1 stimulated aortic smooth muscle cell motility by decreasing H2O2 levels: essential role of cGMP. *Am. J. Physiol. Heart. Circ.* 286:H2103(2004).
- Doi K, et al. Clinical characteristics relevant to myocardial cell apoptosis: analysis of pericardial fluid. *Interactive Cardiovascular and Thoracic Surgery* 3:359(2004).
- Rieusset J, et al. Suppressor of Cytokine Signaling 3 Expression and Insulin Resistance in Skeletal Muscle of Obese and Type 2 Diabetic Patients. *Diabetes* 53:2232(2004).
- Blaszczak N, et al. Osteoblast-Derived Factors Induce Androgen-Independent Proliferation and Expression of Prostate-Specific Antigen in Human Prostate Cancer Cells. *Clinical Cancer Research* 10:1860(2004).
- Barrera A, et al. Mapping of the Hepatitis B Virus Pre-S1 Domain Involved in Receptor Recognition. *J. Virology* 79(15):(2005).

Corning® Primaria™ Cultureware

Cat. No.	Description	Actual Dimensions (mm)	Actual Growth Area (cm ²)	Working Volume (mL)	Qty/ Pk	Qty/ Cs
353801	35 x 10 mm Easy-Grip dish	40.28 O.D. x 6.17	11.78	2.5-3.0	20	200
353802	60 x 15 mm Standard dish	54.81 O.D. x 13.26	21.29	6.0-7.0	20	200
353803	100 x 20 mm Standard dish	89.43 O.D. x 19.18	58.95	16.0-17.5	20	200

Cat. No.	Description	Growth Area (cm ²)	Total Volume (mL)	Qty/ Pk	Qty/ Cs
353813	25 cm ² flask, rectangular, canted neck, plug seal cap	25	50	20	100
353808	25 cm ² flask, rectangular, canted neck, vent cap	25	50	20	100
353824	75 cm ² flask, rectangular, straight neck, vent cap	75	250	5	100
353810	75 cm ² flask, rectangular, straight neck, vent cap	75	250	5	100

Cat. No.	Description	Growth Area (cm ²)	Working Volume (mL)	Qty/ Pk	Qty/ Cs
353846	6-well plate with lid	9.6	15.5	1	50
353847	24-well plate with lid	1.9	3.5	1	50
353872	96-well microplate with lid	0.32	0.37	1	50

Products may not be available in all markets.

Falcon® Cell Culture Inserts and Companion Plates

Falcon Cell Culture Inserts permit the diffusion of media components to both apical and basolateral cell surfaces, mimicking the *in vivo* process

Falcon Cell Culture Inserts are available in convenient 6-, 12-, and 24-well sizes. Packed in individual blister packs and give you the flexibility to run from 1 to 24 samples at one time.

Cell culture on microporous membranes

Cell culture systems containing microporous, permeable membranes have been shown to promote differentiation of a variety of epithelial and mesenchymal cells *in vitro*. Because of the bilateral access to nutrients, cytokines, hormones and other media supplements, cells cultured on permeable supports show a higher degree of morphological and functional differentiation when compared to cells cultured on non-permeable plastic surfaces. Falcon Cell Culture Inserts have been successfully used for a variety of applications, including transport, diffusion, secretion, permeability, and drug uptake studies of natural and synthetic compounds; analysis of cellular uptake of pathogens; *in vitro* toxicology studies using a variety of cells; analysis of cellular migration and invasion of normal and malignant cells; co-culture studies, organoid culture, and air-liquid interface models (e.g., tissue, disease models). Independent access to the apical and basolateral domains of polarized cells permits the study of protein sorting, receptor localization and microbial pathogenesis.

Typical applications for Falcon Cell Culture Inserts

- ▶ Endothelial models for studies of cell-cell interaction, adhesion, angiogenesis, matrix formation, cell-ECM interaction, metastasis, inflammation, and invasion
- ▶ Respiratory epithelium culture for pharmacology, toxicology, cystic fibrosis research, and microbial pathogenesis
- ▶ Renal tubule cell culture for *in vitro* toxicology and pharmacology
- ▶ Normal Human Epidermal Keratinocyte *in vitro* toxicology models
- ▶ Epithelial polarity studies on MDCK, LLPCk, and other cell types
- ▶ Hepatocyte culture for drug toxicity and biotransformation studies
- ▶ Culture of intestinal epithelial cells for drug bioavailability studies

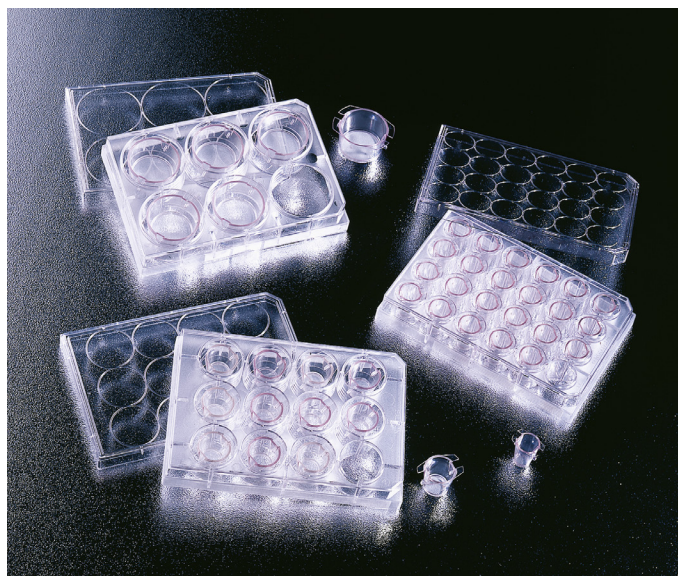

Falcon Cell Culture Inserts contain polyethylene terephthalate (PET) membranes, which are available in a wide variety of pore sizes and densities. The insert housing, also made from PET, is non-treated in order to minimize cell growth on insert side walls. For best results, Falcon Cell Culture Inserts should be used together with Falcon Cell Culture Insert Companion Plates. These Companion Plates are TC-treated and feature a unique labyrinth lid design and condensation rings, which reduce evaporation and contamination.

Due to the low protein binding property of PET membranes, Falcon Cell Culture Inserts are especially suited for immunohistochemistry¹, co-culture to study intercellular communication², transport studies³, and drug screening⁴. Compatibility with fixatives and the durability of PET membranes makes them ideal for both light and electron microscopy.

Select the best membrane for your application

- ▶ Larger pore size membranes for investigating chemotaxis, invasion, and migration
- ▶ Transparent membranes (e.g., PET) for visualization of cells by light microscopy (Figure A, 0.4 μm)
- ▶ High pore density membranes for maximal diffusion when studying transport, secretion, or drug uptake (Figure B, 0.4 μm HD)

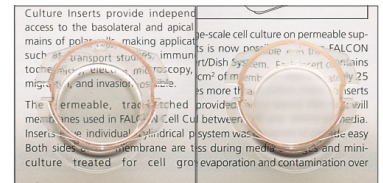

Figure A

Figure B

Falcon® Cell Culture Inserts

- ▶ Low protein binding PET membrane
- ▶ Track-etched PET membranes have a smooth surface and defined cylindrical pores that traverse the membrane
- ▶ A wide variety of configurations including 6-, 12-, and 24-well
- ▶ A broad selection of membrane pore sizes, 0.4, 1.0, 3.0, and 8.0 μm diameter
- ▶ Packed in individual blister packs, 48 inserts/case
- ▶ Insert housings (non-treated) prevent promiscuous growth of cells on the insert walls
- ▶ Innovative hanging design facilitates pipetting and allows for co-culture
- ▶ Sterilized by irradiation

Falcon Cell Culture Insert Companion Plates

Falcon Cell Culture Insert Companion Plates have been specially designed for use with Falcon or Corning® BioCoat® Cell Culture Inserts so evaporation and contamination due to improper lid fit is eliminated.

In the Feeding Position, pipet access is improved for fluid handling on the basolateral side. Reagents can be added quickly and consistently for timed experiments. Aspiration of media from the well is easier, reducing the risk of contamination.

In the Incubation Position, Falcon Cell Culture Inserts remain locked in position in their Falcon Companion Plate wells. Media will not wick up between the insert and well wall. The unique Falcon low-evaporation lid provides a tortuous air-passage system that reduces evaporation and contamination. Falcon Cell Culture Inserts are easy to use with Falcon Companion Plates.

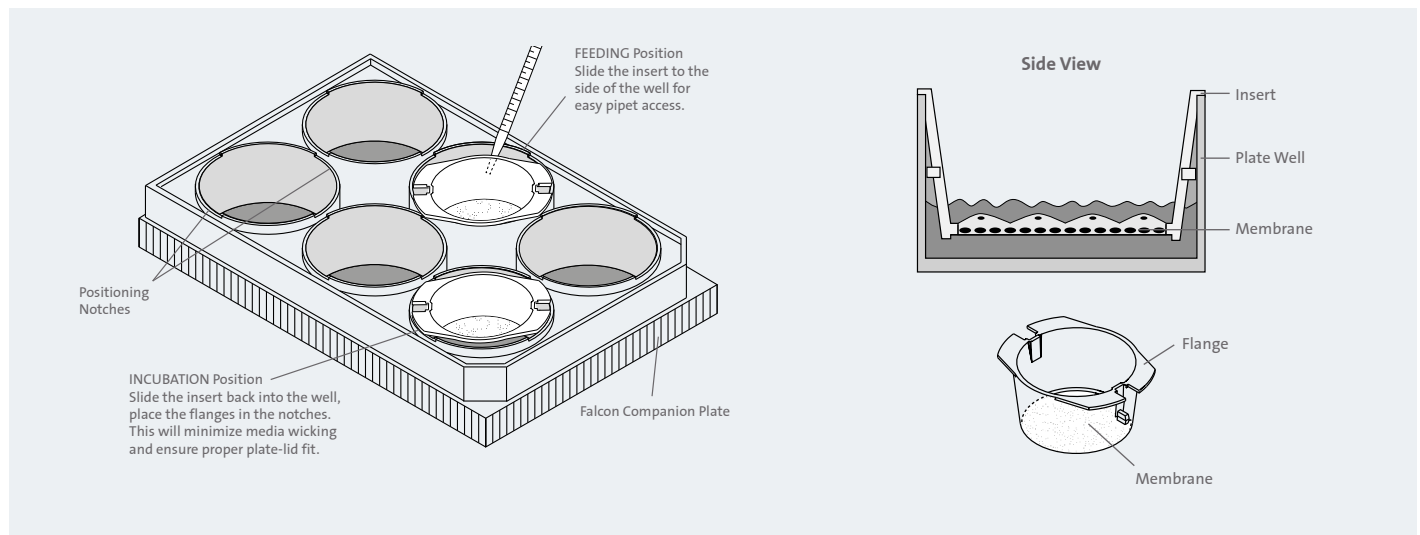

References

1. Hashimoto Y, et al. J Pharmacol Exp Ther 363:275-283 (2017).
2. Lehmann TP, et al. Mol Med Rep. 9:574 (2014).
3. Speer JE, et al. J. Biol Eng. 13:36 (2019).
4. Ribocco-Lutkiewicz, et al. Sci Rep. 8:1873 (2018).

Falcon® Cell Culture Inserts and Companion Plates (Continued)

Falcon Cell Culture Inserts

Transparent PET Membrane

0.4 µm pore size, 1.6 x 10⁶ pores/cm²

Applications

- ▶ Scanning and transmission electron microscopy
- ▶ Visualization of live cells by light microscopy
- ▶ Removal of membrane from housing
- ▶ Immunocytochemical staining

Cat. No.	Description	Qty/Pkg	Qty/Cs
353090	Inserts for 6-well plates	1	48
353180	Inserts for 12-well plates	1	48
353095	Inserts for 24-well plates	1	48

High Density, Translucent PET Membrane

0.4 µm pore size, 1.0 x 10⁸ pores/cm²

Applications

- ▶ Transport, diffusion and secretion of small molecules into, out of, or through a cell monolayer
- ▶ Barrier function (Trans epithelial Electrical Resistance (TEER) measurements)
- ▶ Drug bioavailability

Cat. No.	Description	Qty/Pkg	Qty/Cs
353493	Inserts for 6-well plates	1	48
353494	Inserts for 12-well plates	1	48
353495	Inserts for 24-well plates	1	48

Transparent PET Membrane

1.0 µm pore size, 1.6 x 10⁶ pores/cm²

Applications

- ▶ General-purpose membrane
- ▶ Growth and visualization of live cells
- ▶ Transport, secretion, and diffusion of most molecules into, out of, and through cell monolayers
- ▶ Immunocytochemical staining
- ▶ Drug bioavailability assays
- ▶ In general, this is the maximum pore size available to prevent cell migration through pores

Cat. No.	Description	Qty/Pkg	Qty/Cs
353102	Inserts for 6-well plates	1	48
353103	Inserts for 12-well plates	1	48
353104	Inserts for 24-well plates	1	48

Transparent PET Membrane

3.0 µm pore size, 8 x 10⁵ pores/cm²

Applications

- ▶ Visualization by light microscopy
- ▶ Transmission and scanning electron microscopy
- ▶ Useful for studying transport of larger molecules (lipoproteins) and viruses
- ▶ Transendothelial migration
- ▶ Smooth muscle migration
- ▶ Endothelial cell migration

NOTE: In long-term cultivation, epithelial cells grown in a monolayer may traverse a naked membrane and grow on the top and bottom of the membrane.

Cat. No.	Description	Qty/Pkg	Qty/Cs
353091	Inserts for 6-well plates	1	48
353181	Inserts for 12-well plates	1	48
353096	Inserts for 24-well plates	1	48

High Density, Translucent PET Membrane

3.0 µm pore size, 2 x 10⁶ pores/cm²

Applications

- ▶ Transport, secretion and diffusion of large molecules or viruses
- ▶ Cell migration studies
- ▶ This pore size offers maximum diffusion of large molecules or viruses

NOTE: In long-term culture, epithelial cells grown in a monolayer may traverse a naked membrane and grow on the top and bottom of the membrane.

Cat. No.	Description	Qty/Pkg	Qty/Cs
353092	Inserts for 6-well plates	1	48
353292	Inserts for 12-well plates	1	48
353492	Inserts for 24-well plates	1	48

Transparent PET Membrane

8.0 µm pore size, 1 x 10⁵ pores/cm²

Applications

- ▶ Tumor invasion
- ▶ Cell migration
- ▶ Chemotaxis
- ▶ Metastasis

Cat. No.	Description	Qty/Pkg	Qty/Cs
353093	Inserts for 6-well plates	1	48
353182	Inserts for 12-well plates	1	48
353097	Inserts for 24-well plates	1	48

Products may not be available in all markets.

Physical Specifications for Falcon® Cell Culture Inserts

	6-well	12-well	24-well
Effective Diameter of Membrane (mm)	23.1	10.5	6.4
Effective Growth Area of Membrane (cm ²)	4.2	0.9	0.3
Insert Height (mm)	17.2	17.2	17.5
Distance from Membrane to the Bottom of the Well (mm)	0.9	0.9	0.8
Suggested Media in Insert (mL)	1.5-2.5	0.4-1.0	0.2-0.35
Suggested Media in Well (mL)	2.7-3.2	1.4-2.3	0.7-0.9
Growth Area in Plate Well (cm ²)	9.6	3.8	2.0

The following Application Notes are available at www.corning.com/lifesciences.

No.	Title	Lit. Code
401	Maintenance and Functional Properties of Primary Turtle Bladder Epithelial Cells Cultured on Falcon Permeable Supports	CLS-DL-CC-060
402	Falcon Cell Culture Permeable Supports as a Support Substrate for an In Vitro Extracellular Matrix System	CLS-DL-CC-061
405	Preparation of Falcon Cell Culture Permeable Supports for Scanning Electron Microscopy	CLS-DL-CC-062
406	Preparation of Falcon Cell Culture Permeable Supports for Transmission Electron Microscopy	CLS-DL-CC-063
407	An In Vitro Assay for Study of Neutrophil Migration Through Interstitial Matrix Using Falcon Cell Culture Permeable Supports	CLS-DL-CC-064
408	Induction of Lymphoproliferation by Antigen-Primed Macrophages Across the Falcon Cell Culture Permeable Support	CLS-DL-CC-065
409	Use of Falcon Cell Culture Permeable Supports to Reconstruct a Differentiated Human Epidermis In Vitro: Expression of Cell Adhesion Molecules (Integrins)	CLS-DL-CC-066
412	A Physiological and Morphological In Vitro Model for Normal Human Urothelium Cultured on Falcon Cell Culture Permeable Supports	CLS-DL-CC-067
413	<i>In Vitro</i> Study of Cytokine-mediated Activation of Endothelial Cell Permeability Using Falcon Cell Culture Permeable Supports	CLS-DL-CC-068
459	Preparation of Falcon Cell Culture Permeable Supports for Confocal Indirect Immunofluorescence: Fixation and Staining of Caco-2/bbe (C2) Cells with Various Dyes	CLS-DL-CC-079
463	Use of Falcon Cell Culture Permeable Supports to Evaluate Allelopathic Effects Among Marine Phytoplankters <i>In Vitro</i>	CLS-DL-CC-081

For additional references or for help with an application, contact Corning Life Sciences Scientific Support.

Falcon Cell Culture Insert Companion Plates

Specifically designed for use with Falcon or Corning® BioCoat® Cell Culture Inserts. Tissue Culture-treated, polystyrene, sterile, nonpyrogenic, with lid. May be used with or without cell culture inserts.

Cat. No.	Description	Qty/Pkg	Qty/Cs
355467	6-well plate (deep-well)	1	4
353502	6-well plate	1	50
353503	12-well plate	1	50
353504	24-well plate	1	50

Products may not be available in all markets.

Tips

- ▶ Falcon Cell Culture Inserts are also available in an automation friendly, one-piece Multiwell Insert plate format. Available in 1.0, 3.0, and 8.0 µm pore sizes for manual and robotic screening of cells. See pages 25 and 27 for more detailed information.
- ▶ Falcon Cell Culture Inserts are also available with consistently pre-applied extracellular matrix (ECM) proteins and ECM components for improved cell attachment, growth or differentiation. For more information, visit www.corning.com/lifesciences.
- ▶ For applications based on fluorescent techniques see Corning FluoroBlok™ Inserts (pages 29 and following).
- ▶ You may have to increase your seeding density (number of cells/cm²) when changing from non-permeable polystyrene to permeable cell culture surfaces. Start with seeding cell densities 25-50% higher. The time for initial attachment may also increase.
- ▶ To avoid air bubbles forming under the inserts, use pre-warmed media and follow the directions from the Guidelines for Using Falcon Cell Culture Inserts (PD104401) available at www.corning.com/lifesciences.
- ▶ To improve cell attachment to uncoated inserts, incubate inserts for 20 to 30 minutes with media (containing serum if it will be used) before adding cells.

Falcon® 24 Multiwell Insert Systems

Free your lab from tedious manipulation of individual cell culture inserts with Falcon 24 Multiwell Insert Systems. Each system contains an automation-friendly 24-well cell culture membrane insert suitable for both manual and robotic screening of cells in bioavailability, toxicity, cell migration, and tumor invasion assays.

- ▶ Automate and increase productivity and throughput of cell culture insert-based assays
- ▶ Designed for bioavailability, transport, permeability, cell migration, and tumor invasion studies

Falcon 24 Multiwell Insert Systems are designed to automate many commonly used cell-based assays for drug discovery. Available in a choice of membrane pore sizes, 24 Multiwell Inserts have been successfully used for a variety of applications including permeability studies for oral bioavailability (e.g., Caco-2 cells), chemotaxis, cell migration and invasion assays. These insert systems offer all the benefits of Falcon Individual Cell Culture Inserts in an automation-friendly format that is compatible with most robots and fluid handlers. The Falcon 24 Multiwell Insert Plate is a single unit that is compatible with all Falcon 24-well plates and Feeder Tray.

Typical applications for Falcon 24 Multiwell Insert Systems

- ▶ Culture of intestinal epithelial cells (e.g., Caco-2 cells) for drug bioavailability and transport studies
- ▶ Barrier function [TEER] measurements of epithelial cells (i.e., MDCK cells)
- ▶ Epithelial polarity studies of protein sorting, receptor location, and vectorial transport
- ▶ Hepatocyte cultures for drug toxicity and biotransformation
- ▶ Angiogenesis studies
- ▶ Tumor cell invasion and migration

Physical Specifications

Falcon 24 Multiwell Insert Systems and Cell Culture Insert Companion Plates

Effective Diameter of Membrane (mm)	6.5
Effective Growth Area of Membrane (cm ²)	0.3
Distance of Membrane to Bottom of Well (mm)	2
Insert Height (mm)	18
Suggested Media Volume in Insert (µL)	300-500
Suggested Media Volume in Well (µL)	1000-1400
Effective Growth Area in 24-well Plate (cm ² per well)	2
Pore Density: 1.0 µm inserts (pores/cm ²)	1.6 x 10 ⁶
Pore Density: 3.0 µm inserts (pores/cm ²)	8.0 x 10 ⁵
Pore Density: 8.0 µm inserts (pores/cm ²)	1.0 x 10 ⁵

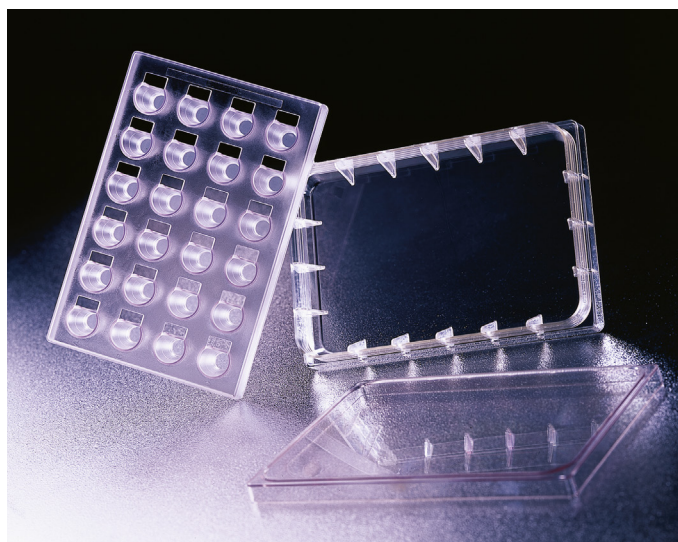

Falcon 24 Multiwell Insert Systems

Falcon 24 Multiwell Insert Systems

with Feeder Tray and Lid

Cat. No.	Description	Qty/Cs
351181	1 µm pore size	5

Falcon 24 Multiwell Insert Systems

with 24-well Plate and Lid

351183	3 µm pore size	5
351185	8 µm pore size	5

Falcon 24-well Feeder Tray

Specifically designed for use with Falcon 24 Multiwell Insert Systems

351182	Feeder tray with lid	5
--------	----------------------	---

Falcon 24-well Plates

For use with Falcon 24 Multiwell Insert Systems

353047	Standard tissue culture	1	50
353226	Standard tissue culture	6	36
353935	Standard tissue culture	10	60
353847	Corning® Primaria™ tissue culture	1	50
351147	Not treated	1	50

Products may not be available in all markets.

The following Application Note is available at www.corning.com/lifesciences.

No.	Title	Lit. Code
419	Design and Evaluation of an Automation-Compatible Multiwell Insert for Cell-based Assays	CLS-DL-CC-072

For additional references or for help with an application, contact Corning Life Sciences Scientific Support.

Falcon® 96 Multiwell Insert Systems

Automate and miniaturize your xenobiotic permeability and transport studies

The Falcon 96 Multiwell Insert System is a cell culture insert platform suitable for both manual and robotic screening of compounds in cell-based assays. The system has been tested for its ability to produce a differentiated monolayer of Caco-2, LLC-PK₁, and MDCK cells making it an ideal platform for *in vitro* bioavailability and permeability studies.

This automation compatible platform is composed of a 1.0 µm pore size PET membrane-based 96 Multiwell Insert Plate, Media Feeder Tray, and a Lid. The drop-in baffle for the Feeder Tray mitigates media sloshing and lowers the risk of contamination. To analyze individual samples, simply transfer the insert plate into the Falcon 96 Square Well, Angled-bottom Plate. If desired, the Falcon 96 Square Well, Angled-bottom Plate may be used in conjunction with the insert for culturing the cells, eliminating the transfer step from the single-well feeder tray for sample analysis.

- ▶ Automation compatible design
- ▶ Format compatible with most robots and fluid handling instruments
- ▶ Complete sample recovery
- ▶ The Falcon 96 Square Well, Angled-bottom Plate features an angled bottom for more complete sample utilization
- ▶ Excellent reproducibility
- ▶ One-piece feeder tray enhances consistency in well-to-well monolayer growth
- ▶ Total assay flexibility—ideal for transport studies
- ▶ System can be used with many cell lines including Caco-2, MDCK, and LLC-PK₁, for basal to apical or apical to basal measurements of drug transport

Intra-Plate Reproducibility of the Falcon 96 Multiwell Insert System

Format used to Culture Monolayers	TEER (ohms cm ²)	Mannitol P _{app} (x 10 ⁻⁶ cm/sec)	Ritonavir P _{ap} (x 10 ⁻⁶ cm/sec)
Falcon 96 Square Well, Angled-bottom Plate	272 (CV=26%)	0.72 (CV=22%)	9.0 (CV=13%)
Falcon Feeder Tray for 96 Multiwell Insert	420 (CV=16%)	0.70 (CV=13%)	11.0 (CV=2.5%)

Permeability measured in Caco-2 cell monolayers cultured for 21-days in the Falcon Feeder Tray or Falcon 96 Square Well, Angled-bottom Plate. While the Feeder Tray with drop-in baffle facilitates medium renewal, comparable results can be obtained in either format. Culturing cells in the Falcon Feeder Tray enhances consistency in well-to-well monolayer growth (TEER values) and function (P_{app} values).

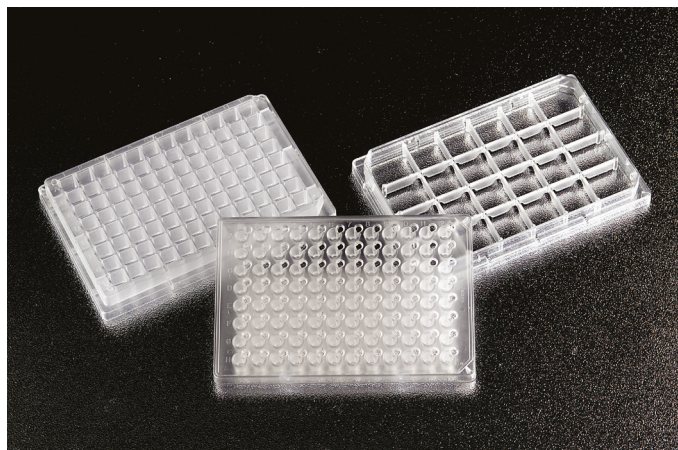

Physical Specifications

Falcon 96 Multiwell Insert Systems

Effective Diameter of Membrane (mm)	3.2
Effective Growth Area of Membrane (cm ²)	0.0804
Insert Height (mm)	10.4
Distance from Membrane to the Bottom of Well (mm)	
Low side inner	2.87
High side inner	4.27
Suggested Media Volume in Insert (mL)	0.5-0.75
Suggested Media Volume in Well (mL) (square well, angled bottom plate)	0.26
Growth Area in Companion TC Plate Well (cm ²)	0.64

Falcon 96 Multiwell Insert Systems

Falcon 96 Multiwell Insert Systems

Cat. No.	Description	Qty/Pk
351131	Five insert plates with feeder trays and lids	5
353938	Five insert plates with 96 square well, angled-bottom plates and lids	5

Falcon 96 Square Well, Angled-bottom Plate and Lid

353925	Polystyrene, nonpyrogenic, not treated	5
--------	----------------------------------------	---

Falcon 96-well Feeder Tray and Lid

353924	Polystyrene, nonpyrogenic, not treated	5
--------	----------------------------------------	---

Products may not be available in all markets.

Corning® FluoroBlok™ Cell Culture Inserts

Increase cell migration and invasion assay productivity with real-time fluorescence

Corning FluoroBlok Cell Culture Inserts are available as convenient 24-well individual inserts in two different pore sizes. Packed in individual blister packs, Corning FluoroBlok Cell Culture Inserts give you the flexibility to run from 1 to 24 samples at one time.

Detect cell migration and invasion in a homogeneous fluorescent assay system

Corning FluoroBlok Cell Culture Inserts are designed with a unique light-tight PET membrane that efficiently blocks the transmission of light within the range of 400-700 nm. Fluorescently labeled cells present in the top chamber of the insert are made invisible by the Corning FluoroBlok membrane. Once labeled cells migrate through the membrane, they are no longer shielded from the light source and are easily detected with a fluorescence plate reader.

- ▶ Simplify insert-based assays—Unique, light-tight PET membrane makes it easy to specifically detect fluorescently labeled cells and molecules below the insert.
- ▶ Increase insert assay productivity—Save time and labor in chemotaxis, cell migration, and invasion assays by automating your assay detection with real-time fluorescence.
- ▶ Eliminate cell culture insert manipulation—Get rapid data collection using a fluorescence microplate reader or microscope without the need for plate washing or tedious, manual cell scraping and counting. Chart migration of cells and molecules in real time without dismantling or destroying the insert.

Applications

Corning FluoroBlok effectively blocks >99.0% of the light transmission from 400-700 nm, allowing you the flexibility to choose from a variety of fluorophores for bioavailability, toxicity, chemotaxis, cell migration, and tumor invasion assays. As long as the fluorophores of choice are within the blocking range of the Corning FluoroBlok membrane, multiplex detection is also possible.

Physical Specifications

Corning FluoroBlok Cell Culture Inserts

Effective Diameter of Membrane (mm)	6.4
Effective Growth Area of Membrane (cm ²)	0.3
Distance from Membrane to Bottom of Well (mm)	17.5
Insert Height (mm)	0.8
Suggested Media Volume in Insert (mL)	0.2-0.35
Suggested Media Volume in Well (mL)	0.7-0.9
Growth Area in Companion TC Plate Well (cm ²)	2.0
Pore Density: 3.0 μm Inserts (pores/cm ²)	8 ± 2 × 10 ⁵
Pore Density: 8.0 μm Inserts (pores/cm ²)	6 ± 2 × 10 ⁴

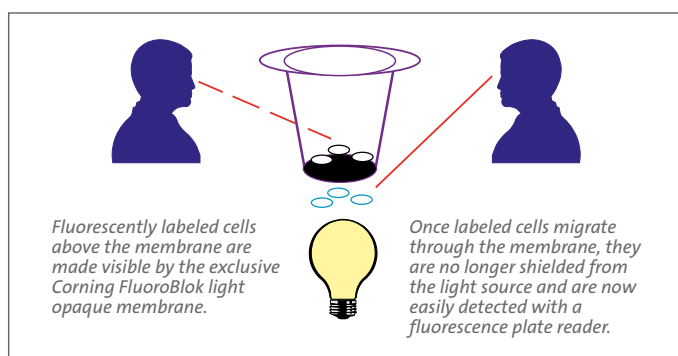

Fluorescent cells and molecules are easily detected as they migrate through Corning FluoroBlok Inserts.

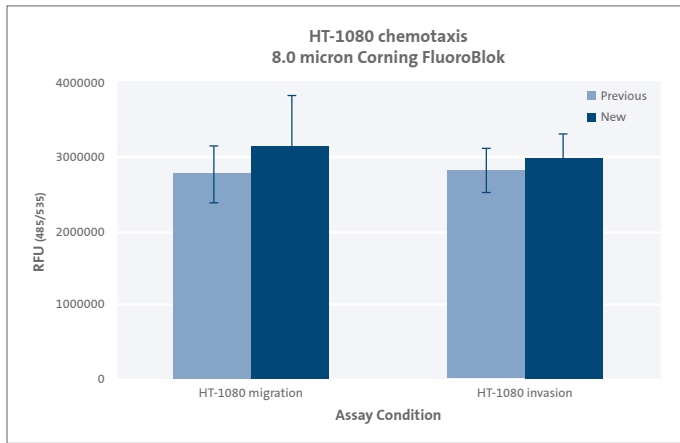

Migration (uncoated inserts) and invasion (Corning Matrigel® matrix-coated inserts) of HT-1080 cells. The invasion index (invasive HT-1080 cells: non-invasive 3T3 cells) was 10.9 for the previous membrane and 10.1 for the new membrane. Z' factors (a statistical characteristic of assay suitability) were previous, 0.616; new, 0.558 (previous, n=6, new, n=24).

Tips

- Cell labeling efficiencies will vary depending on fluorophore and cell type. For optimized conditions, titration of fluorophore is recommended.
- Visit www.corning.com/lifesciences for information on compatible and incompatible fluorophores, frequently asked questions, and application notes.

Corning® FluoroBlok™ Cell Culture Inserts

Corning FluoroBlok Cell Culture Inserts

Cat. No.	Description	Qty/Pk	Qty/Cs
351151	3.0 µm inserts for 24-well plates	1	48
351152	8.0 µm inserts for 24-well plates	1	48

Falcon® Cell Culture Insert Companion Plates

Specifically designed for use with Falcon or Corning BioCoat® Cell Culture Inserts. Tissue culture-treated polystyrene, sterile, nonpyrogenic, with lid. May be used with or without cell culture inserts.

353504	24-well plate	1	50
--------	---------------	---	----

Products may not be available in all markets.

The following Application Notes are available at www.corning.com/lifesciences.

No.	Title	Lit. Code
451	Compatible Fluorophores and Dyes for Corning FluoroBlok Inserts and Insert Systems	CLS-DL-CC-077
497	New PET Membrane for Corning FluoroBlok 3.0 µm and 8.0 µm Pore Size Cell Culture Inserts	CLS-DL-CC-042

For additional references or for help with an application, contact Corning Life Sciences Scientific Support.

Corning® FluoroBlok™ 24 Multiwell Insert Systems

Increase cell migration and invasion assay productivity with simplified fluorescence detection and real-time analysis

Each Corning FluoroBlok 24 Multiwell Insert System contains an automation-friendly 24 Multiwell cell culture membrane insert suitable for both manual and robotic screening of cells or compounds. Handle 24 inserts simultaneously; all 24 inserts are part of a single unit that is compatible with Falcon 24-well Plates and Feeder Tray.

Corning FluoroBlok 24 Multiwell Insert Systems

The Corning FluoroBlok Insert System is made with a unique light-tight PET membrane that effectively blocks the transmission of light from 400-700 nm. Fluorescence from labeled cells or compounds present in the top chamber of the insert system is blocked from detection in the bottom chamber by the intervening dyed membrane. Once fluorescently labeled cells or compounds pass through the membrane, they are no longer shielded from the light source and are easily detected with a bottom-reading fluorescence plate reader. The wide blocking range of the Corning FluoroBlok membrane allows the flexibility to choose a variety of fluorophores for chemotaxis, cell migration, tumor cell or bacterial invasion, leukocyte extravasation, cell signaling, toxicity and permeability studies for oral bioavailability and absorption assays (e.g., Caco-2 cells).

- ▶ Save time and labor using automated fluorescence detection
- ▶ Eliminate cell insert manipulation—get rapid data collection without the need for plate washing or manual cell scraping and counting. Chart migration of cells and molecules in real-time without dismantling or destroying the insert
- ▶ Increase sample throughput—automate many commonly used membrane-based cell assays and increase the efficiency, productivity and throughput of these assays in the drug discovery process
- ▶ Handle 24 inserts simultaneously—all 24 wells are part of a single unit that is compatible with Falcon 24-well plates and Feeder Tray
- ▶ Each insert has a generous, automation-compatible sampling port. When used with Falcon 24-well plates, users can sample above and below the membrane with standard 200 µL or 1000 µL pipet tips or automated fluid handler tips.

References

1. Crouch MF, et al. *J. Cell. Biol.* 152:263 (2001).
2. Crouch MF, *J. Neuro. Meth.* 104:87 (2000).
3. Townson JR, et al. *J. Biol. Chem.* 275:39254 (2000).
4. Yamakawa S, et al. *Biol. Pharm. Bull.* 10:1264 (2000).
5. Tang S, et al. *J. Cell Biol.* 147:1073 (1999).



Physical Specifications

Corning FluoroBlok 24 Multiwell Insert Systems

Effective Diameter of Membrane (mm)	6.5
Effective Growth Area of Membrane (cm ²)	0.3
Distance from Membrane to Bottom of Well (mm)	2
Insert Height (mm)	18
Suggested Media Volume in Insert (µL)	300-500
Suggested Media Volume in Well (µL)	1000-1400
Effective Growth Area in 24-well Plate (cm ²)	2
Pore Density: 3.0 µm Inserts (pores/cm ²)	8 ± 2 × 10 ⁵
Pore Density: 8.0 µm Inserts (pores/cm ²)	6 ± 2 × 10 ⁴

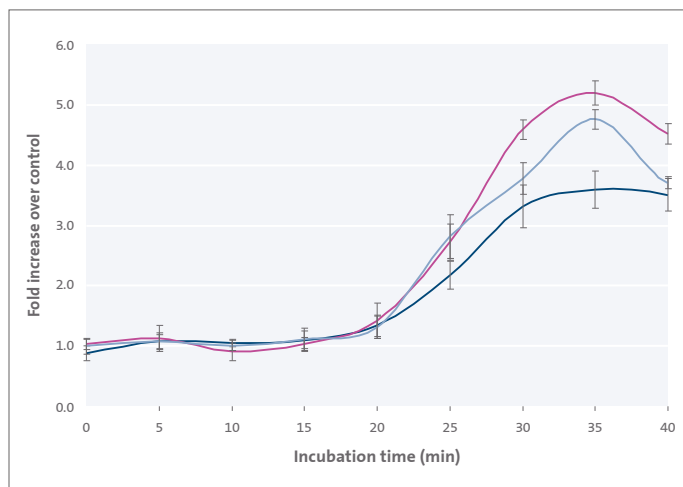

Run kinetic assays easily. Calcein AM labeled THP-1 cells (a monocytic cell line) were seeded at 100,000 cells/well on fibronectin coated inserts and chemotaxis to 25 nM MCP-1 (R&D Systems) was measured using a PerkinElmer EnVision® plate reader. Peak response time in three separate assays (n=3) was 30-35 min.

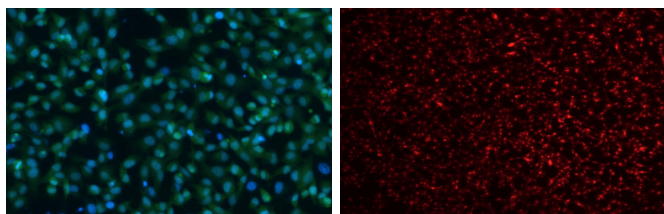

Fluorescence multiplexing. Migrated HT-1080 cells post-labeled with Hoechst 33342 (blue) and Calcein AM (green) [left] or pre-labeled with DiIC₁₂(3) (red) [right].

Tips

- Cell labeling efficiencies will vary depending on fluorophore and cell type. For optimized conditions, titration of fluorophore is recommended.
- Visit www.corning.com/lifesciences for information on compatible and incompatible fluorophores, frequently asked questions, and application notes.

Corning® FluoroBlok™ 24 Multiwell Insert Systems

Corning FluoroBlok 24 Multiwell Insert Systems

with 24-well Plate and Lid

Cat. No.	Description	Qty/Pk
351156	3.0 µm pore size	5 plates
351157	8.0 µm pore size	1 plate
351158	8.0 µm pore size	5 plates

Falcon® 24-well Feeder Tray

Specifically designed for use with Corning FluoroBlok 24 Multiwell Insert Systems

351186	Feeder Tray with lid	5 plates
--------	----------------------	----------

Falcon 24-well Plates

For use with Corning FluoroBlok 24 Multiwell Insert Systems

Cat. No.	Description	Qty/Pk	Qty/Cs
353047	Standard tissue culture	1/tray	50
353226	Standard tissue culture	6/bag	36
353935	Standard tissue culture	10/RS Tray*	60
353847	Corning Primaria™ surface	1/tray	50
351147	Not treated	1/tray	50

*Ready-Stack Tray

Products may not be available in all markets.

The following Application Notes are available at www.corning.com/lifesciences.

No.	Title	Lit. Code
436	Set Up Guidelines and Dimensional Templates for Fluorescence Plate Readers used with Corning FluoroBlok Insert Systems and Corning BioCoat® Multiwell Insert Cell-Based Assays	CLS-DL-CC-074
441	Screening of Anti-Metastatic Compounds Using ZsGreen1 Reef Coral Fluorescent Protein (RCFP) Labeled HT-1080 Tumor Cells	CLS-DL-CC-075
442	Screening of Anti-Metastatic Compounds by a Fluorescence-Based Tumor Cell Invasion Assay	CLS-DL-CC-076
451	Compatible Fluorophores and Dyes for Corning FluoroBlok Inserts and Insert Systems	CLS-DL-CC-077
484	Migration of Human Mesenchymal Stem Cells Using Corning FluoroBlok Cell Culture Inserts	CLS-DL-CC-054

For additional references or for help with an application, contact Corning Life Sciences Scientific Support.

Corning® FluoroBlok™ 96 Multiwell Insert Systems

The Corning FluoroBlok 96 Multiwell Insert System is a cell culture assay platform designed with automation in mind. The one-piece insert housing and fluorescence blocking microporous membrane (available in 3.0 and 8.0 µm pore sizes) enables increased efficiency, productivity and throughput in the drug discovery process. The novel receiver plate design minimizes crosstalk between the wells; the black housing of the 96 Multiwell Insert virtually eliminates autofluorescence. These features ensure fluorescence measurements that result from your assay, not crosstalk or background signal.

- ▶ A solution for automated, high throughput cell-based studies of chemotaxis, migration and invasion
- ▶ Increase cell migration and invasion assay productivity with simplified fluorescence detection and real-time analysis
- ▶ Simplification of chemotaxis, cell migration, and invasion assays
- ▶ Standard technology platform allows multiple protocols
- ▶ Homogeneous protocols for real-time kinetic readouts
- ▶ Real-time detection without dismantling or destroying the insert
- ▶ Increased sample throughput
- ▶ Eliminates need for manual cell scraping and counting
- ▶ Automation friendly
- ▶ 96 Multiwell format is compatible with commercial detectors and fluid handling instruments
- ▶ Unique fluorescence blocking membrane
- ▶ Blocks greater than 99% of the excitation and emission wavelengths of fluorophores commonly used to label cells

References

1. Dong J, et al. EMBO 23(14):2800 (2004).
2. Nick J, et al. Blood 104(13):3878 (2004).
3. Shen X, et al. Exp. Cell Res, 294(2):420 (2004).
4. Meissner M, et al. Circ. Res., 94(3):324 (2004).
5. Bockhorn M, et al. Cancer Res. 64(7):2469 (2004).
6. Kuijpers TW, et al. Blood 103(10):3915 (2004).
7. Violeta C, et al. Mol Bio Cell 16(6):2947 (2005).
8. Sheng-Bin P, et al. Mol Cancer Research 3:227 (2005).

Tips

- ▶ Cell labeling efficiencies will vary depending on fluorophore and cell type. For optimized conditions, titration of fluorophore is recommended.
- ▶ Visit www.corning.com/lifesciences for information on compatible and incompatible fluorophores, frequently asked questions, and application notes.

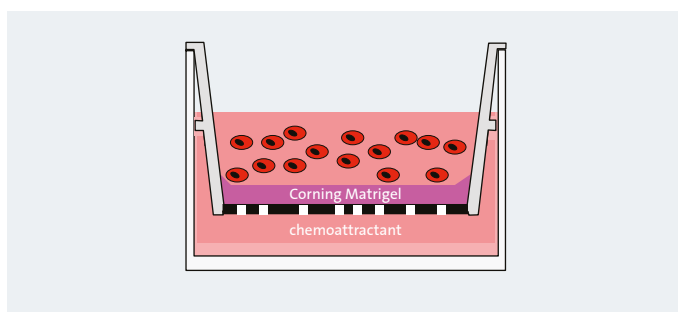
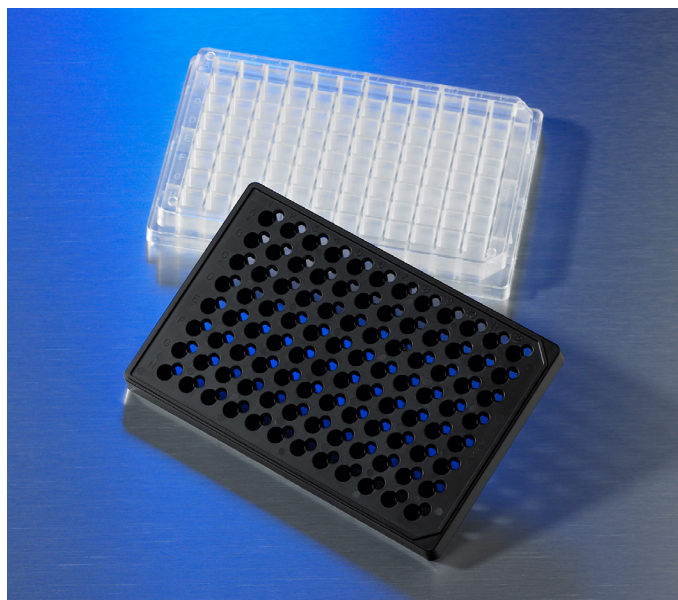

Cell Migration/Invasion assays using a Corning FluoroBlok Membrane.

The PET membrane is dyed to block the excitation and emission wavelengths of fluorophores commonly used to label cells, such as Calcein AM and DiI. Greater than 99% of input fluorescence in the insert is blocked by the dyed membrane. Fluorescently labeled cells stimulated by a chemoattractant, pass through the membrane. The non-migrated population does not have to be removed from the inserts prior to analysis and no further manipulation is required to quantitate the results using a bottom-reading fluorescence plate reader.

Simplify and automate cell-based assays using the Corning® FluoroBlok™ 96 Multiwell Insert System

The Corning FluoroBlok 96 Multiwell Insert System, designed with automation in mind, is well suited for high-throughput analysis of cell-based assays. Good detection sensitivity is observed even when a small number of cells is added to the wells. Variability is also low, as CV values of 10% and below are routinely observed.

The wide blocking range (400-700 nm) of the Corning FluoroBlok membrane allows the flexibility to choose from a variety of fluorophores for screening compounds in cell-based assays such as chemotaxis, cell invasion and migration, and monolayer permeability. Unlike traditional *in vitro* cell-based assays, the Corning FluoroBlok 96 Multiwell Insert System allows rapid data collection without the need for plate washing or tedious manual cell scraping and counting. Each insert has a generous automation-compatible sampling port so you may sample above and below the membrane with standard pipet tips or automated fluid handling equipment. The 96 Multiwell Insert Plate format is compatible with many standard fluorescence plate readers, robots and fluid handlers.

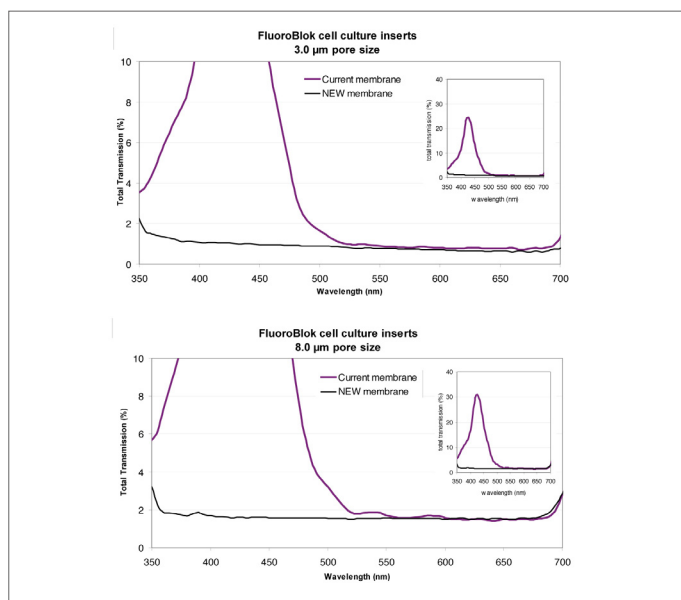

Total Transmission Spectra for 3.0 µm (top) and 8.0 µm (bottom) pore size Corning FluoroBlok inserts as measured by transmission spectrophotometry using HunterLab UltraScan® PRO. Insert detail expanded y axis results.

Physical Specifications

Corning FluoroBlok 96 Multiwell Insert Systems

Effective Diameter of Membrane (mm)	3.2
Effective Growth Area of Membrane (cm ²)	0.0804
Distance from Membrane to Bottom of Well (mm)	1.4
Insert Height (mm)	10.4
Suggested Media Volume in Insert in µL (optimum volume: 50 µL)	30-70
Suggested Media Volume in Well in µL (optimum volume: 225 µL)	200-225
Effective Growth Area in 96-Square Well Flat Bottom Plate (cm ² per well)	0.64
Pore Density: 3.0 µm Inserts (pores/cm ²)	8 ± 2 × 10 ⁵
Pore Density: 8.0 µm Inserts (pores/cm ²)	6 ± 2 × 10 ⁴

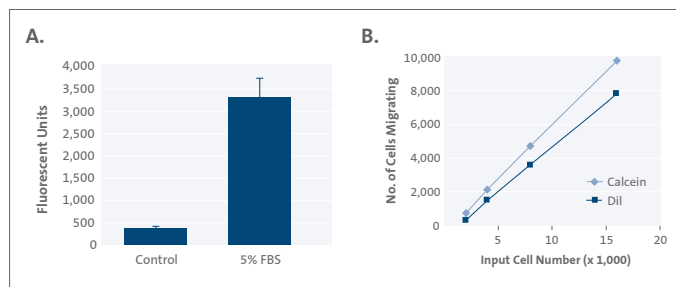

A. HUVEC Migration through Corning FluoroBlok 96 Multiwell Inserts (3.0 µm pore size). HUVEC cells were plated at a density of 2.5×10^4 cells per well on the top of the insert suspended in assay medium. Into the bottom wells, assay medium (control) or chemoattractant (5% FBS in assay medium) were added and the plates were incubated at 37°C for 20 hours in a cell culture incubator. Cells were labeled with fluorescent dyes and cells that migrated to the bottom of the membrane were quantitated using a fluorescence plate reader.

B. HT-1080 Migration through Corning FluoroBlok 96 Multiwell Inserts (8.0 µm pore size). Relationship of migrated cells versus input cell number. The four-hour fluorescence data was converted to cells migrated using the standard curve. The relationship was linear at all cell concentrations. This data indicates that the number of pores in the small membrane area was not saturated, even at higher cell numbers.

Corning FluoroBlok 96 Multiwell Insert Systems

Corning FluoroBlok 96 Multiwell Insert Systems

Cat. No.	Description	Qty/Pk
351161	3.0 µm pore size	1 plate
351162	3.0 µm pore size	5 plates
351163	8.0 µm pore size	1 plate
351164	8.0 µm pore size	5 plates

Falcon 96 Square Well, Flat-Bottom Microplate and Lid

353928	96 square well, flat-bottom microplate	5 plates
--------	----------------------------------------	----------

Products may not be available in all markets.

The following Application Notes are available at www.corning.com/lifesciences.

No.	Title	Lit. Code
450	Corning FluoroBlok 96 Multiwell Insert System Enhances High-Throughput Analysis of Cell-Based Assays	CLS-DL-CC-035
436	Set up Guidelines and Dimensional Templates for Fluorescence Plate Readers used with Corning FluoroBlok Insert Systems and Corning BioCoat® Multiwell Insert Cell-Based Assays	CLS-DL-CC-074
451	Compatible Fluorophores and Dyes for Corning FluoroBlok Inserts and Insert Systems	CLS-DL-CC-077
457	Optimized Chemotaxis Conditions for Primary Blood Monocytes or THP-1 Cells using Corning FluoroBlok 96 Multiwell Insert Plates	CLS-DL-CC-078

For additional references or for help with an application, contact Corning Life Sciences Scientific Support.

Falcon® Microplates Key Dimensions

96-well Microplates		A	B	C	D	D ¹
TC-treated Cat. No.	Not Treated Cat. No.	Plate Bottom Length	Plate Bottom Width	Plate Height	Well Top Diameter	Well Bottom Diameter
353072, 353916, 353936	—	127.63	85.11	14.30	6.85	6.35
353075	351172	127.48	85.52	14.30	6.85	6.35
353296	—	127.49	85.45	14.25	6.73	5.68
353376	—	127.76	85.48	14.40	6.96	6.58
353077, 353227	351177, 353910	127.76	85.59	14.30	6.85	6.35
353219, 353377	—	127.26	85.48	14.40	6.96	6.58
—	351190	127.48	85.56	14.35	6.75	6.45
—	353263	127.48	85.56	14.61	6.96	—

CONTINUED ➤

384-well Microplates		A	B	C	D	D ¹
Cat. No.		Plate Bottom Length	Plate Bottom Width	Plate Height	Well Top Diameter	Well Bottom Diameter
353961, 353988	—	127.76	85.48	14.40	3.70	3.30
353962, 353963	—	127.76	85.48	14.40	3.70	3.30

CONTINUED ➤

96-well Microplate

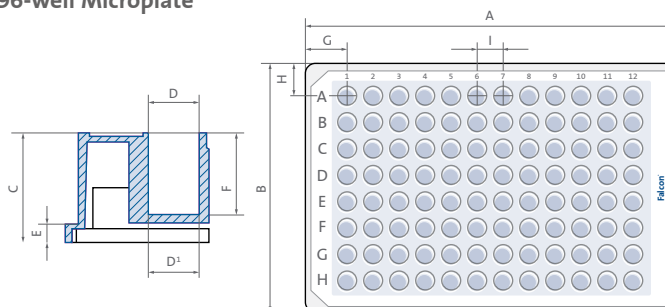

For lid dimensions, contact Corning Life Sciences Scientific Support or visit www.corning.com/lifesciences.

Dimensions in mm unless otherwise specified.

E	F	G	H	I						
Flange	Well Depth	Left Edge to A1 Center	Top Edge to A1 Center	Well Center to Center	Bottom Thickness (μm)	Well Bottom Shape	Total Volume (μL)	Working Volume (μL)	Growth Area (mm ²)	Upper Well Shape
6.10	10.76	14.37	11.34	8.99	—	Flat	370	40-275	31.6	Round
6.10	10.76	14.40	14.40	8.98	—	Flat	370	40-275	31.6	Round
6.10	10.59	14.38	11.39	8.99	—	Flat	300	50-200	25.4	Round
2.50	10.90	14.38	11.24	9.00	—	Flat	392	25-340	34	Round
6.10	10.59	14.38	11.39	8.99	—	Round	320	50-250	—	Round
2.50	10.90	14.38	11.24	9.00	190	Flat	392	25-340	34	Round
2.49	11.86	14.23	11.33	8.99	—	Round	340	60-200	—	Round
2.50	10.90	14.24	11.35	9.00	—	Conical	340	100-250	—	Round

E	F	G	H	I						
Flange	Well Depth	Left Edge to A1 Center	Top Edge to A1 Center	Well Center to Center	Bottom Thickness (μm)	Well Bottom Shape	Total Volume (μL)	Working Volume (μL)	Growth Area (mm ²)	Upper Well Shape
2.50	11.50	12.13	8.99	4.50	—	Flat	131	15-110	10	Rounded-square
2.50	11.50	12.13	8.99	4.50	190	Flat	131	15-110	10	Rounded-square

384-well Microplate

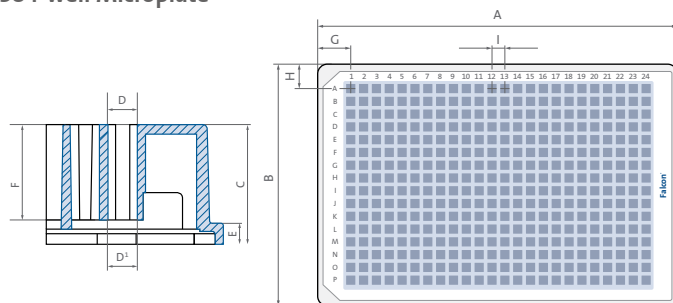

Working Volumes for Tissue Culture Vessels

Vessel Type	Volume of Media (per item)	Volume of Trypsin* (per item)	Actual Growth Area (per item)
Dishes			
35 x 10 mm style	2.5-3 mL	0.2-0.3 mL	11.78 cm ²
60 x 15 mm style	6-7 mL	0.5-0.6 mL	21.29 cm ²
100 x 20 mm style	16-17.5 mL	1 mL	58.95 cm ²
150 x 25 mm style	45-50 mL	1.5 mL	156.36 cm ²
Multiwell and Assay Plates			
6-well plate	2.5-3 mL	0.2-0.3 mL	9.6 cm ²
12-well plate	1.5-2.2 mL	0.1-0.2 mL	3.8 cm ²
24-well plate	0.8-1 mL	0.08-0.1 mL	2 cm ²
48-well plate	0.5-0.8 mL	0.05-0.08 mL	0.75 cm ²
96-well microplate	0.1-0.2 mL	0.1-0.2 mL	0.32 cm ²
384-well microplate	15-110 µL	--	10 mm ²
384-well microplate, small volume	4-25 µL	--	2.7 mm ²
1536-well microplate	3-10 µL	--	2.3 mm ²
Multiwell and Assay Plates			
12.5 cm ²	4-5 mL	0.25-0.40 mL	12.5 cm ²
25 cm ²	8-9 mL	0.50-0.80 mL	25 cm ²
75 cm ²	20-30 mL	1 mL	75 cm ²
150 cm ²	40-50 mL	2 mL	150 cm ²
175 cm ²	45-55 mL	2 mL	175 cm ²
225 cm ²	60-100 mL	4-5 mL	225 cm ²
525 cm ² (3-layer)	6-50 mL per layer	6 mL	525 cm ²
875 cm ² (5-layer)	6-50 mL per layer	10 mL	875 cm ²

*Your lab protocol may call for another proteolytic enzyme.

Cell Record Worksheet

Copy this form and use it in your lab's documentation procedures.

Characterization:

Name _____ Abbreviation _____

Morphology _____

Origin _____

Source Primary Culture _____ Date _____

ATCC _____ Passage _____ Date _____

Other _____ Passage _____ Date _____

- Biosafety Level Class I — no virus/no contamination; subprimate or normal primate origin
 Class II — virus/mycoplasma; clinical material, primate cells of tumor origin
 Class III — HIV preps/T-cell lines

Proliferation:

Population Doubling Time _____ hours

- Fast (requires handling every 1-2 days)
 Medium (requires handling every 3-4 days)
 Slow (requires handling once per week)

Split Ratio _____:_____

Routine Seeding Density _____

Handling:

Viability (Cells not used beyond passage) _____

- Cell Removal Mechanical/Scraping
 Enzymatic
 Trypsin
 Other _____

Cell Culture Vessels (brand/size) _____

- Culture vessel surface Not treated TC-treated Corning Primaria™
 Collagen I Fibronectin Laminin
Lot # _____ Corning® Matrigel® Matrix Other

Media:

Type _____

Serum _____

Lot # _____

Additives/Supplements (include lot #s)

(Applicable vitamins, growth factors, antibiotics, etc.)

Storage Location:

Refrigerator _____ Freezer _____

_____ _____

% _____ Fetal Bovine Serum (FBS)

Other _____ _____ _____

_____ _____

_____ _____

_____ _____

_____ _____



Additional Falcon® Labware

Table of Contents

Bacteriological Petri Dishes	36
Cell Strainers and Containers	37
Library Storage Plates	38

An array of products for general laboratory use

In addition to Falcon cultureware, Corning also manufactures:

- ▶ A variety of dishes with durable construction for stable dish manipulation
- ▶ Cell strainers available in three nylon mesh pore sizes for optimal performance
- ▶ Containers that are sterile and disposable to provide secure samples
- ▶ Polypropylene plates for short- and long-term compound storage

These high quality Falcon products deliver consistent, reliable results.

Falcon® Bacteriological Petri Dishes

- ▶ Durable construction for stable dish manipulation
- ▶ Crystal-grade, virgin polystyrene for optical clarity
- ▶ Dimensions listed (Diameter x Height)
- ▶ Sterile

Tips

- ▶ When using automated filling systems, a heavier-weight dish (e.g., Cat. No. 351029, 100 mm dish) prevents equipment from jamming.



Falcon Bacteriological Petri Dishes

Cat. No.	Description	Actual Dimensions (OD x H, mm)	Qty/Pk	Qty/Cs
Easy-Grip Style				
351008	35 x 10 mm	40.28 x 6.17	20	500
Standard Style				
351007	60 x 15 mm	54.81 x 13.26	20	500
351029	100 x 15 mm	87.91 x 13.72	20	500
351058	150 x 15 mm	142.37 x 17.15	10	100
Tight-fit Lid Dish				
351006	50 x 9 mm	50.25 x 8.26	20	500

Products may not be available in all markets.

Falcon® Cell Strainers and Containers



Falcon Cell Strainers

- ▶ A faster and easier alternative to gauze filtration in procedures involving dissociation of cells from either clumps or primary tissues
- ▶ Consistently obtain a more uniform single-cell suspension
- ▶ Three nylon mesh pore sizes for optimal performance in a variety of applications
- ▶ Sterilized and conveniently accessible in individual packaging
- ▶ Extended lip on strainer enables aseptic handling with forceps
- ▶ Strainers are made of a strong nylon mesh with 40, 70, or 100 µm pores that are evenly spaced for consistent results
- ▶ Molded color-coded polypropylene frame with tab enables easy handling

Features

- ▶ Individually packaged
- ▶ Sterile

Falcon Cell Strainers

Cat. No.	Description	Qty/Pk	Qty/Pk
352340	40 µm/blue	1	50
352350	70 µm/white	1	50
352360	100 µm/yellow	1	50

Products may not be available in all markets.

Tips

- ▶ A special sterile cell strainer assembly designed for cell sorting devices is listed on page 56. It contains a 35-micron nylon mesh strainer that is an integral part of the cap to a 5 mL polystyrene tube.



Falcon Containers

- ▶ Sterile, disposable polypropylene containers provide secure sample containment
- ▶ Available in 4½ oz. (110 mL) and 8 oz. (220 mL) sizes both with and without lids
- ▶ Feature molded-in graduations for easy measurements
- ▶ Graduated in ounces and milliliters to provide convenient, single-use, timesaving containers for collection and storage of a wide variety of specimens
- ▶ Inert and chemically resistant to commonly used laboratory reagents at room temperature

Features

- ▶ Sterile
- ▶ 4½ oz. graduations from ½ oz. to 4½ oz. in ¼ oz. increments and from 20 mL to 110 mL in 10 mL increments
- ▶ 8 oz. size graduated from ¼ oz. to 8 oz. in ¼ oz. increments and from 20 mL to 220 mL in 10 mL increments

Falcon Containers

Cat. No.	Description	Qty/Pk	Qty/Pk
354013	4½ oz. (110 mL) with lid	1	100
354014	4½ oz. (110 mL) without lid	20	500
354015	8 oz. (220 mL) with lid	1	100
354020	8 oz. (220 mL) without lid	20	500
354017	Lid for both sizes	20	500

Products may not be available in all markets.

Related Products

- ▶ Falcon Round-Bottom Tube with Cell Strainer Cap. 36
- ▶ Falcon 50 mL Conical Tubes 37

Falcon® Library Storage Microplates

- ▶ 96-well library storage microplates with round- or V-bottom well shapes
- ▶ Made from virgin polypropylene resin
- ▶ Convenient for compound storage
- ▶ Exceedingly rigid and flat microplate for consistent automated handling
- ▶ Plate withstands repeated freeze-thaws down to -20°C
- ▶ Low retention polypropylene and round-well design give low residual volumes after pipetting (<0.1 µL)
- ▶ Raised well edges and flatness for heat or adhesive sealing



Falcon 96-well Library Storage Microplates

Cat. No.	Description	Total Volume (µL)	Well Shape	Sterile	Notch	Qty/Pk	Qty/Cs
351190	96-well library storage microplate	340	Round	No	H12	25	100
353263	96-well library storage microplate	340	V-bottom	No	A1-H1	25	100

Products may not be available in all markets.

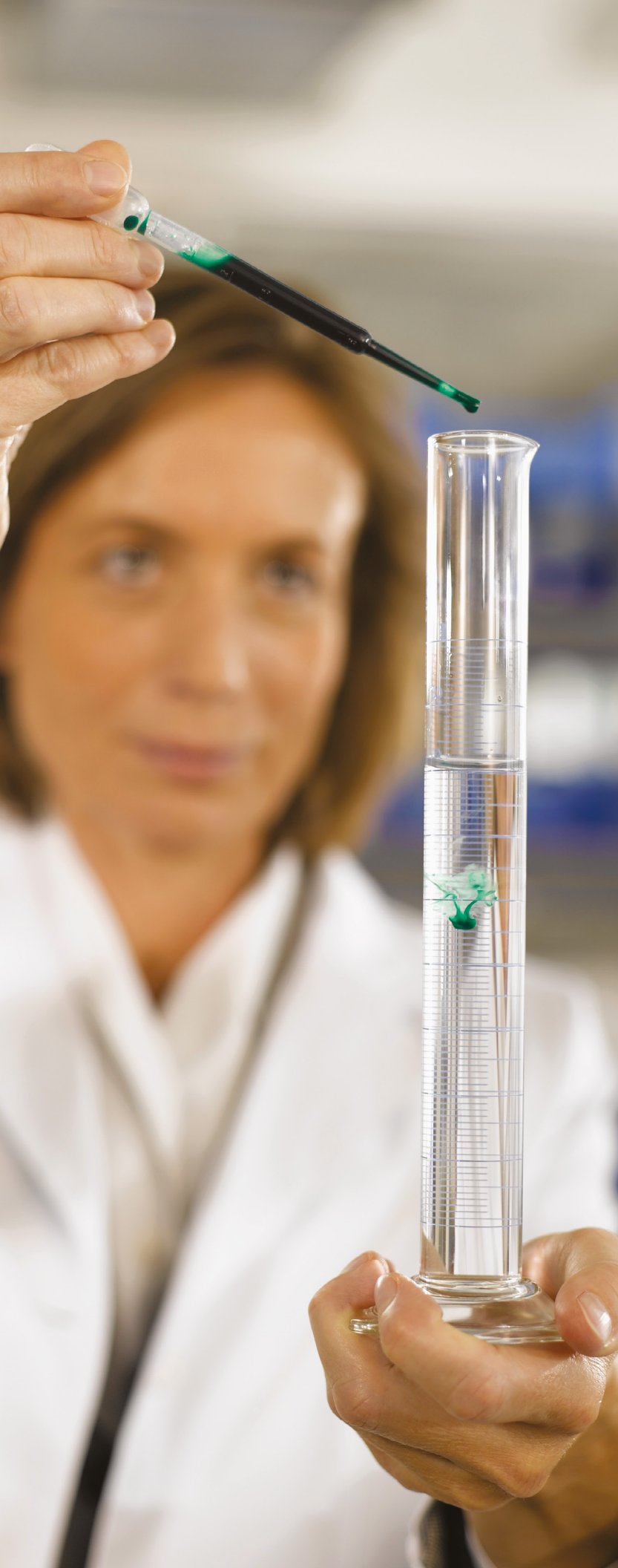

Falcon® Pipets and Pipet Controller

Table of Contents

Serological Pipets	40
Individually Wrapped Serological Pipets	41
Bulk-Packaged Serological Pipets	42
Aspirating Pipets	43
Transfer Pipets	43
Pipet Controller.	44

Falcon® Pipets
and Pipet Controller

The perfect pipet in a perfect package

Falcon pipets, first in quality and first in innovation, are manufactured at our EN ISO 13485 certified and QSR (21 CFR 820) compliant facility in a state-of-the-art, high-performance work environment. Dedicated product teams use advanced technologies and techniques, combined with rigorous quality control procedures to ensure the integrity of every pipet.

Each pipet component is made of the highest quality polystyrene resin. Process control and attention to detail guarantee the finest quality product. A critical volumetrics test verifies the accuracy of each pipet by measuring the delivered volume.

The final result is consistently high quality pipets that provide precise and accurate liquid handling.

Falcon® Serological Pipets

- ▶ Individually wrapped polystyrene pipets available in paper-plastic or all-plastic thermoform packaging
- ▶ Range in size from 1 mL to 100 mL
- ▶ Exceptionally crisp, dark, easy-to-read printed graduations
- ▶ Graduation alignment system brings graduations to view quickly
- ▶ Available in bulk packaging
- ▶ Color-coded pipets facilitate correct size selection

Sterile pipet packaging

- ▶ Customer demand for a sterile product has shaped the design of all Falcon brand products, especially serological pipets and pipet packaging. In the thermoform packaging process, heavy-gauge plastic material is heated and drawn to form a pouch. The pipet is placed in the pouch, and the pouch is sealed. Depending on user preference, the top web may be either paper or our Corning® Advantage® all-plastic material. This packaging ensures Falcon pipets are delivered to you contamination-free.

Falcon 100 mL pipet

- ▶ The Falcon 100 mL pipet has up to a 110 mL graduated capacity, with total holding capacity of 125 mL—the highest currently available. Its innovative, stepped design allows it to fit easily into most media bottles and tissue culture vessels.

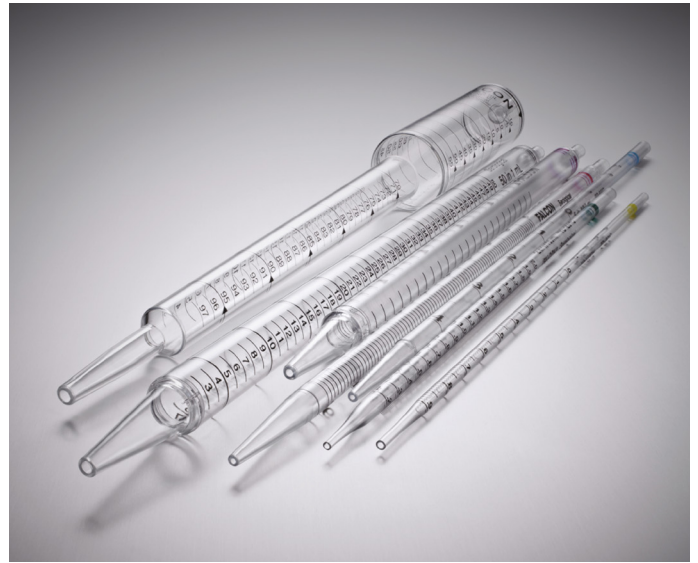

Falcon® Individually Wrapped Serological Pipets

- ▶ Polystyrene, disposable pipets for tissue culture, bacteriological, and research applications
- ▶ Available in two thermoformed package styles: the popular paper-plastic wrap and the Corning Advantage all-plastic wrap
- ▶ Negative graduations for extra capacity
- ▶ Reverse graduations (except 1 mL)
- ▶ Color-coded package and markings for ease of identification
- ▶ Polyester plug to help prevent overfill
- ▶ Accurate $\pm 2\%$ at full volume (excluding 1 and 2 mL)
- ▶ Noncytotoxic, nonpyrogenicity tested to less than 0.1 EU/mL
- ▶ Sterile



Corning Advantage pipet packaging for customers who prefer an all-plastic pipet wrapper

The Corning Advantage all-plastic individual pipet package offers:

- ▶ Reduced static cling
- ▶ Easy opening options: peel-open and pop-through
- ▶ Low particulates
- ▶ Complete recyclability

Falcon Individually Wrapped Serological Pipets

Paper-Plastic Thermoform Cat. No.	Corning® Advantage® All-Plastic Cat. No.	Size	Color	Increments	Overfill Capacity	Qty/Pk	Qty/Cs
357521	356521	1 mL	Yellow ●	1/100	0.4 mL	100	1,000
357507	356507	2 mL	Green ●	1/100	0.8 mL	100	1,000
357543	356543	5 mL	Blue ●	1/10	2.5 mL	50	200
357551	356551	10 mL	Red ●	1/10	3.0 mL	50	200
357525	356525	25 mL, Space Saver	Purple ●	0.25	7.0 mL	50	200
357535	356535	25 mL, Extended	Purple ●	0.50	11.0 mL	50	200
357550	356550	50 mL	Black ●	1.0	10.0 mL	25	100
—	357600	100 mL	Black ●	1.0	15.0 mL	5	50

Products may not be available in all markets.

Falcon® Bulk-packaged Serological Pipets

- ▶ Polystyrene, disposable pipets for tissue culture, bacteriological, and research applications
- ▶ Come in sturdy polyethylene bags
- ▶ Negative graduations for extra capacity
- ▶ Reverse graduations (except 1 mL)
- ▶ Color-coded package and markings for ease of identification
- ▶ Polyester plug to help prevent overfill
- ▶ Accurate $\pm 2\%$ at full volume (excluding 1 and 2 mL)
- ▶ Noncytotoxic, nonpyrogenicity tested to less than 0.1 EU/mL
- ▶ Sterile

Graduation alignment system

The pipet graduation alignment system is a fast and simple way to bring graduations to your line of sight. Simply pop open or peel back the top of the pipet package and line up the pipettor before completely removing the pipet from its wrapping. When you remove the pipet from its package, the graduations should face you every time.



Convenient pipet graduation alignment system—exclusively from Corning.

Falcon Bulk-packaged Serological Pipets

Paper-Plastic Thermoform

Cat. No.	Size	Color	Increments	Overfill Capacity	Qty/Pk	Qty/Cs
357506	1 mL	Yellow ●	1/100	0.4 mL	25	1,000
357508	2 mL	Green ●	1/100	0.8 mL	25	1,000
357529	5 mL	Blue ●	1/10	2.5 mL	25	500
357530	10 mL	Red ●	1/10	3.0 mL	25	500
357515	25 mL, Space Saver	Purple ●	0.25	7.0 mL	20	200

Products may not be available in all markets.

Falcon® Aspirating Pipets

- ▶ Safer alternative to glass Pasteur pipets
- ▶ Can be used for all vacuum-aspirating procedures
- ▶ Individually packaged in thermoformed paper-plastic wrap to ensure sterile presentation
- ▶ Noncytotoxic, nonpyrogenic tested to less than 0.1 EU/mL
- ▶ Sterile, polystyrene, non-plugged, non-graduated pipets

Falcon Aspirating Pipets

Cat. No.	Size	Qty/Pk	Qty/Cs
357558	2 mL	50	200
357501	5 mL	50	200

Products may not be available in all markets.



Falcon® Transfer Pipets

- ▶ Highly durable, one-piece polyethylene design
- ▶ One squeeze draws 3 mL into this 6-inch transfer pipet
- ▶ Small tip ensures consistent reproduction of drop size
- ▶ Graduated at 1 mL and 2 mL marks

Falcon Transfer Pipets

Cat. No.	Description	Qty/Pk	Qty/Cs
357575	Sterile	1	500
357524	Nonsterile	500	1,000

Products may not be available in all markets.

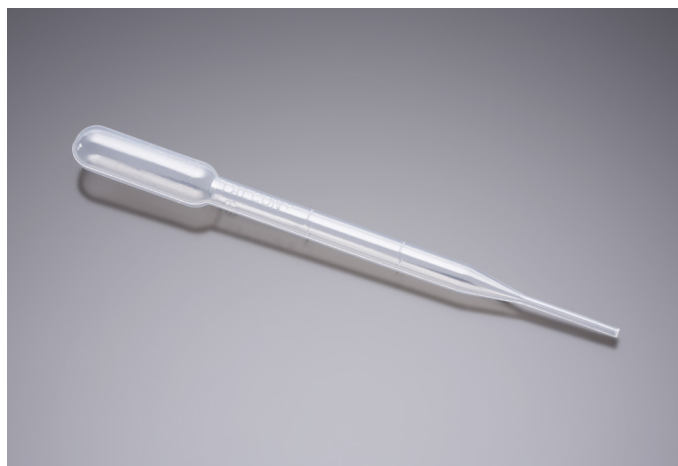

Falcon® Pipet Controller

The light, ergonomic, motorized pipet controller is designed for use with glass and plastic serological pipets from 0.5 to 100 mL volume ranges. Conveniently positioned switches change operating modes and speeds quickly to handle different liquid volumes and viscosities. Aspirating and dispensing speed is controlled through the finger triggers. When fully charged, the batteries enable up to 8 hours of continuous use. The large LCD display clearly indicates battery status, pipetting mode, and speed.

The Falcon Pipet Controller is supplied with a two-position charging stand, a universal battery charger, and three batteries. Two 0.2 µm and two 0.45 µm hydrophobic polytetrafluoroethylene (PTFE) filters are supplied with the pipet controller. Additional filters are available as standard accessories. The filters, pipet holder, and nose piece are autoclavable.

- ▶ Ergonomic design for exceptional comfort
- ▶ LCD display for continuous visualization of speed, modes, and battery status
- ▶ Easy access to the battery compartment
- ▶ Easy maintenance



Two-position Charging Stand

Falcon Pipet Controller

Cat. No.	Description
357469	Falcon Pipet Controller, with two 0.2 µm filters and two 0.45 µm filters, two-position charging stand, universal power supply, and set of 3 batteries

Falcon Pipet Controller Accessories

Cat. No.	Description
357472	Hydrophobic PTFE filter, 0.2 µm (set of 5)
357473	Hydrophobic PTFE filter, 0.45 µm (set of 5)
357474	Silicone pipet holder
357486	Battery set, 3 x AAA, NiMH
357476	Nose piece
357477	Connector gasket
357487	Battery cover, without wings
357488	Battery cover, with wings
357489	Universal power supply, 9V with set of adapters (EU, US, UK, and AUS)
357490	Two-position charging stand
P2028	Wall hanger

Products may not be available in all markets.



Falcon® Tubes

Table of Contents

- Round-bottom Tubes 46**
- Conical Tubes 48**
- Laboratory Aids. 50**
 - Tube Size Identification Chart 50
 - Tube Chemical Resistance Chart. 51
 - Characteristics of Falcon Plasticware. 52
 - Nomogram for Computing Relative Centrifugal Force 54

Test the sample, not the tube

Your life sciences research demands the most stable and controlled environment possible for the analysis of biological and chemical samples. At Corning Life Sciences, we manufacture our Falcon conical and round-bottom tubes from advanced bioanalytical-grade resins. Our polymer selection process includes extensive testing to ensure that the polymer does not leach unwanted substances and provides for low protein binding. Falcon tubes and our medical-style packaging provide unsurpassed convenience and consistency.

Falcon® Round-bottom Tubes

The foundation for consistent research results

- ▶ Nonpyrogenicity tested to less than 0.1 EU/mL
- ▶ Meets USP Class VI
- ▶ Sterile
- ▶ Provide reliable containment of laboratory fluid samples
- ▶ Widely referenced in published procedures and protocols
- ▶ Polypropylene tubes are best suited for applications requiring greater thermal and chemical stability
- ▶ Polystyrene tubes are best suited for procedures requiring high optical clarity
- ▶ Dual-position snap caps, heavier gauge walls, and unique construction provide a secure, positive seal
- ▶ Medical-style packaging materials

Tips

- ▶ Tubes with more consistent inner tolerance, such as the Falcon 5 mL round-bottom tubes, reduce maintenance and wear of the Bal Seal O-ring resulting in less down time and costly repairs of valuable instruments.
- ▶ Racks for 15 mL Falcon conical tubes are also ideal for upright storage of Falcon 17 x 100 mm (14 mL) round-bottom tubes.
- ▶ Expanded polystyrene racks are not recommended for storage below 0°C.

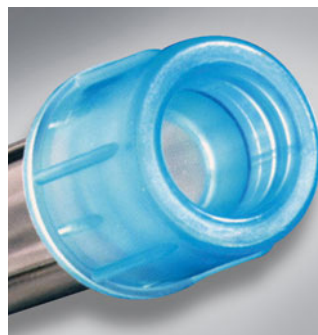

Sterile tube with cell-strainer cap
Designed for flow cytometry applications, the 12 x 75 mm tube with cell strainer cap (Cat. No. 352235) offers a convenient way to prepare laboratory samples. A 35 µm nylon mesh is incorporated into the tube cap, which can be used to collect the dissociated sample for downstream processing in instruments.



Falcon 14 mL polypropylene tubes feature blue printed graduations rather than traditional molded-in graduations. Easy-to-read markings and a solvent-resistant white writing patch provide further convenience in use.

Falcon Round-bottom Tubes

Polystyrene Round-bottom Tubes

▶ 1,400 RCF rating*

▶ Tube dimensions and volumes are approximate

Cat. No.	Size (mm)	Volume (mL)	Cap	Qty/Pk	Qty/Cs
352003	12 x 75	5	Snap	1	500
352058	12 x 75	5	Snap	25	500
352054	12 x 75	5	Snap	125	1,000
352052	12 x 75	5	None	125	1,000
352008**	12 x 75	5	None	1,000	1,000
352235	12 x 75	5	Cell strainer, sterile	125	1,000
352027	13 x 100	8	Screw	125	1,000
352001	17 x 100	14	Snap	1	500
352057	17 x 100	14	Snap	25	500
352051	17 x 100	14	Snap	125	1,000
352017	17 x 100	14	None	125	1,000
352037	16 x 125	16	Screw	1	500
352025	16 x 125	16	Screw	125	1,000
352045	16 x 150	19	Screw	1	500

*RCF claims refer to Relative Centrifugal Force measured in g-force for materials with a specific gravity of 1.0, used in an appropriate rotor with correct cushion and safety precautions. Tubes used with organic solvents at temperatures below 0°C may have lower RCF ratings.

**Nonsterile.

High-clarity Polypropylene Round-bottom Tubes

▶ 3,000 RCF rating*

▶ 17 x 100 mm tubes have blue printed graduations and white writing patch

▶ Tube dimensions and volumes are approximate

Cat. No.	Size (mm)	Volume (mL)	Cap	Qty/Pk	Qty/Cs
352063	12 x 75	5	Snap	25	500
352053	12 x 75	5	None	125	1,000
352002**	12 x 75	5	None	100	1,000
352006	17 x 100, printed	14	Snap	1	500
352059	17 x 100, printed	14	Snap	25	500
352018	17 x 100, printed	14	None	125	1,000

Polyethylene Snap Caps

▶ Dual position snap cap, offering vented as well as fully closed options

▶ For use with both polystyrene and polypropylene tubes

▶ Sterilized by gamma irradiation

Cat. No.	Description	Qty/Pk	Qty/Cs
352032	For 12 x 75 mm tubes	500	2,000

Products may not be available in all markets.

Related Products

▶ Falcon Conical Tubes 37

Falcon® Conical Tubes

Falcon high-clarity conical tubes feature blue printing: dark blue graduations to help avoid eye strain, and a white writing patch that allows sample identification. For large fluid samples, use convenient 175 mL and 225 mL sizes. Made of durable polypropylene, these tubes allow for efficient large-scale laboratory centrifugation.

- ▶ Meet bioanalytical-grade requirements and provide unsurpassed performance in critical research applications
- ▶ Unique double threaded cap design reducing cross threading and leakage
- ▶ Easy-to-read graduations
- ▶ Consistent biological and physical properties
- ▶ Ideal for long-term cryogenic storage of specimens at -80°C (15 to 225 mL polypropylene tubes)

Your dependable tube in the lab

Falcon conical tubes are easy-to-use, high quality tools to protect your precious samples. State-of-the-art design and manufacturing create tubes engineered to provide high strength, wide temperature stability, and to perform in your critical applications. They will protect your valuable samples during centrifugation, vortexing, and long-term storage in the freezer. To meet this intense challenge, Falcon tubes are designed for:

- ▶ **High strength:** State-of-the-art mold design, coupled with advanced resin selection, create tube walls that are engineered to perform under high-stress situations.
- ▶ **Nonpyrogenicity:** Tested to less than 0.1 EU/mL.
- ▶ **Nontoxicity:** Resins are selected via an intense array of U.S. Pharmacopoeia (USP) toxicity tests.
- ▶ **Low protein binding:** Corning engineers and scientists are continually searching for materials and processes that minimize labware-induced interference, such as protein binding.
- ▶ **Quality packaging:** Falcon tubes, in addition to offering bioanalytical-grade performance, use medical-style packaging to better assure sterile presentation. The conical tubes are packaged in convenient reusable racks or compact bulk packs.
- ▶ **Falcon high-clarity conical tubes feature blue printing:** dark blue graduations to help avoid eye strain, and a white writing patch that allows sample identification. For large fluid samples, use convenient 175 mL and 225 mL sizes. Made of durable polypropylene, these tubes allow for efficient large-scale laboratory centrifugation.
- ▶ **The 50 mL conical tubes are available in either bulk- or rack-packaged configurations.** For the convenience of oriented, sterile product presentation, choose the recyclable, expanded polystyrene foam rack option. For applications that do not require the convenience of tubes in racks, choose the bulk-package option with 40% less packaging material.



Tips

- ▶ When marking tubes, black ink Sharpie® pens are the most resistant to alcohol. Other colors tend to smudge.
- ▶ Racks for 15 and 50 mL Falcon conical tubes are ideal for upright storage.
- ▶ Expanded polystyrene racks are not recommended for storage below 0°C.

Falcon Conical Tubes

15 mL Capacity Tubes

- ▶ Approximate dimensions (OD x L): 17 x 120 mm
- ▶ Noncytotoxic and nonpyrogenic
- ▶ Dark blue printed graduations and white writing patch
- ▶ Polyethylene dome-seal screw cap offers positive seal over full circumference
- ▶ Rack can be separated into two sections
- ▶ Sterile

Cat. No.	Description	RCF Rating*	Qty/Pk	Qty/Cs
352196	15 mL, high clarity polypropylene, with free empty rack	12,000	50	500
352096	15 mL, high clarity polypropylene	12,000	50	500
352097	15 mL, high clarity polypropylene, in rack	12,000	50	500
352095	15 mL, polystyrene	1,800	50	500
352099	15 mL, polystyrene, in rack	1,800	50	500

50 mL Capacity Tubes

- ▶ Approximate dimensions (OD x L): 30 x 115 mm
- ▶ Sterile, noncytotoxic, and nonpyrogenic
- ▶ Dark blue printed graduations and white writing patch
- ▶ Polyethylene flat-top screw cap allows one hand manipulation and provides a level writing area

Cat. No.	Description	RCF Rating*	Qty/Pk	Qty/Cs
352070	50 mL, high clarity polypropylene	16,000	25	500
352098	50 mL, high clarity polypropylene, in rack	16,000	25	500
358206	Screw caps for 50 mL tubes	—	50	1,000

175 mL and 225 mL Capacity Tubes

- ▶ 175 mL capacity approximate dimensions (OD x L): 61 x 118 mm
- ▶ 225 mL capacity approximate dimensions (OD x L): 61 x 137 mm
- ▶ Sterile
- ▶ Molded graduations
- ▶ Polyethylene plug-seal screw cap

Cat. No.	Description	RCF Rating*	Qty/Pk	Qty/Cs
352076	175 mL, polypropylene	7,500	8	48
352075	225 mL, polypropylene	7,500	8	48

Accessories for 175 mL and 225 mL Capacity Tubes

Cat. No.	Description	Qty/Cs
352090	Cushions and extractor for Cat. Nos. 352076, 352075, nonsterile	8

*RCF claims refer to Relative Centrifugal Force measured in g-force for materials with a specific gravity of 1.0, used in an appropriate rotor with correct cushion and safety precautions. Tubes used with organic solvents at temperatures below 0°C may have lower RCF ratings.

Products may not be available in all markets.

Related Products

- ▶ Falcon Cell Strainers 48
- ▶ Falcon Round-bottom Tubes 36

Falcon® Tube Size Identification Chart

For accurate reordering, compare your tube to these actual-size drawings

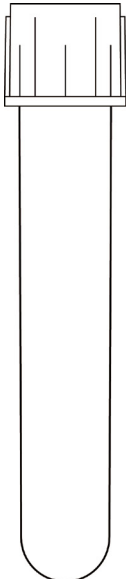
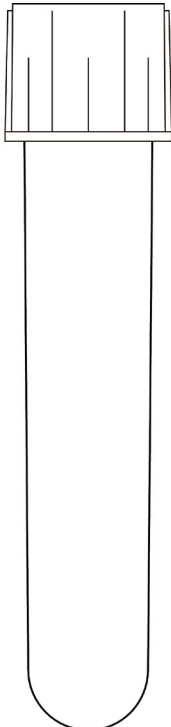
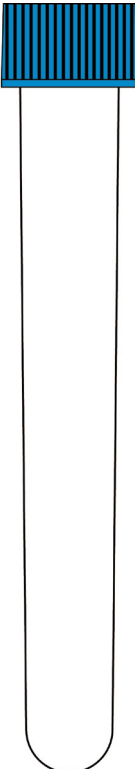
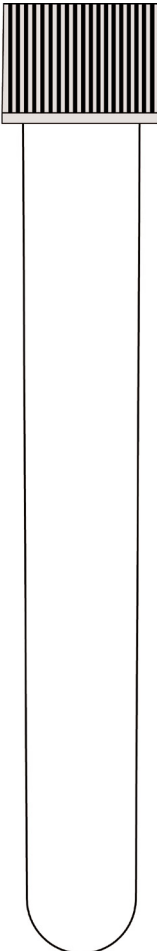
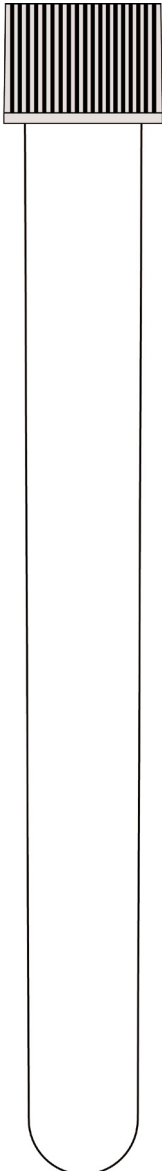
5 mL 12 mm x 75 mm	14 mL 17 mm x 100 mm	8 mL 13 mm x 100 mm	16 mL 16 mm x 125 mm	19mL 16 mm x 150 mm
Snap Cap	Snap Cap	Screw Cap	Screw Cap	Screw Cap
				
Polystyrene	Polystyrene	Polystyrene	Polystyrene	Polystyrene
Cat. No. 352003 352008 352052 352054 352058 352235	Cat. No. 352001 352017 352051 352057	Cat. No. 352027	Cat. No. 352025 352037	Cat. No. 352045
Polypropylene	Polypropylene			
Cat. No. 352002 352053 352063	Cat. No. 352006 352018 352059			

Falcon® Tube Chemical Resistance Chart

	Polypropylene		Polystyrene	
	Room Temp.	50°C to 60°C	Room Temp.	50°C to 60°C
Acetaldehyde	■ ■	X	X	X
Acetic Acid, 5%	■ ■ ■	■ ■ ■	■ ■ ■	■ ■
Acetic Acid, 50%	■ ■ ■	■ ■ ■	■ ■	■ ■
Acetone	■ ■ ■	■ ■ ■	X	X
Acetonitrile	■	X	X	X
Ammonium Acetate, Saturated	■ ■ ■	■ ■ ■	■ ■ ■	■ ■ ■
Ammonium Hydroxide, 5%	■ ■ ■	■ ■ ■	■ ■ ■	■
Ammonium Hydroxide, 30%	■ ■ ■	■ ■	■ ■	■
n-Butyl Alcohol	■ ■ ■	■ ■ ■	■ ■ ■	■ ■
Chloroform	X	X	X	X
Chromic Acid, 50%	■ ■	■	■	■
Cyclohexane	■	X	X	X
Dimethyl Sulfoxide	■ ■ ■	■ ■ ■	■ ■ ■	■ ■
Ether	X	X	X	X
Ethyl Alcohol, 50%	■ ■ ■	■ ■	■ ■	■
Ethyl Alcohol, Absolute	■ ■ ■	■ ■	■	X
Ethylene Glycol	■ ■ ■	■ ■ ■	■ ■ ■	■ ■ ■
Formaldehyde, 10%	■ ■ ■	■ ■ ■	■	X
Formaldehyde, 40%	■ ■ ■	■ ■	X	X
Formic Acid, 5%	■ ■ ■	■ ■	■ ■ ■	■ ■
Formic Acid, 50%	■ ■ ■	■ ■	■	■
Glutaraldehyde	■ ■ ■	■ ■ ■	■ ■ ■	■
Glycerin	■ ■ ■	■ ■ ■	■ ■ ■	■ ■ ■
Glycerol	■ ■ ■	■ ■ ■	■ ■ ■	■ ■ ■
Hydrochloric Acid, 1-5%	■ ■ ■	■ ■ ■	■ ■ ■	■ ■ ■
Hydrochloric Acid, 35%	■ ■ ■	■ ■	■	■
Hydrogen Peroxide, 5%	■ ■ ■	■ ■ ■	■ ■ ■	■ ■
Hydrogen Peroxide, 30%	■ ■ ■	■ ■	■ ■ ■	■ ■
Isobutanol	■ ■ ■	■ ■ ■	■ ■	■ ■
Isopropanol	■ ■ ■	■ ■ ■	■ ■ ■	■ ■
Methyl Alcohol Methanol	■ ■ ■	■ ■ ■	■	X
Methyl Ethyl Ketone	■ ■ ■	■ ■	X	X
Nitric Acid, 1-10%	■ ■ ■	■ ■ ■	■ ■	X
Nitric Acid, 70%	X	X	X	X
Phenol, Liquid	X	X	X	X
Phosphoric Acid, 1-5%	■ ■ ■	■ ■ ■	■ ■ ■	■ ■ ■
Phosphoric Acid, 85%	■ ■ ■	■ ■	■ ■ ■	■ ■
Picric Acid	X	X	■ ■	■
Pine Oil	■ ■ ■	■ ■	X	X
Potassium Hydroxide, 1%	■ ■ ■	■ ■ ■	■ ■	■ ■
Potassium Hydroxide, Concentrated	■ ■ ■	■ ■ ■	■ ■	■ ■
Sodium Hydroxide, 50% to Saturated	■ ■ ■	■ ■ ■	■ ■ ■	■ ■ ■
Sulfuric Acid, 10%	■ ■ ■	■ ■	■ ■ ■	■ ■
Sulfuric Acid, 98% Concentrated	□	X	X	X
Trichloroacetic Acid	■	X	■	X
Tris Buffer, Solution	■ ■ ■	■ ■	■ ■	X

Compatibility with chemical:

- ■ ■ Excellent
- ■ Good
- Fair
- X Not recommended for continual use

Characteristics of Falcon® Plasticware

Material	Properties (Re: Lab Use)	Clarity	Autoclave Results	Heat Distortion Point	Burning Rate
Polystyrene (Styrene)	Biologically inert, hard, excellent optical qualities	Clear	Melts	147 - 175°F 64 - 80°C	Slow
High-Impact Polystyrene	Rubber content gives improved strength to styrene	Opaque	Melts	147 - 195°F 64 - 90°C	Slow
Styrene Acrylonitrile	Improved strength over polystyrene	Clear	Melts	195 - 200°F 90 - 93°C	Slow
Polyethylene (High-density)	Biologically inert, high chemical resistance	Opaque	Withstands several cycles	250°F 121°C	Slow
Polyethylene (Low-density)	Biologically inert, high chemical resistance	Opaque	Melts	105 - 120°F 40 - 49°C	Slow
Polypropylene	Biologically inert, high chemical resistance, exceptional toughness	Translucent	Withstands several cycles	250°F 121°C	Slow
Polycarbonate	Clear, very tough, inert, high temperature resistance	Clear	OK	280 - 290°F 138 - 143°C	Self-extinguishing
Methyl Methacrylate (Plexiglass, Lucite)	Finest optical qualities, easily fabricated	Clear	Melts	160 - 190°F 71 - 88°C	Slow
Cellulose Acetate (Acetate)	Clear, tough, somewhat flexible	Clear	Melts	110 - 194°F 43 - 90°C	Slow
Nylon	Tough, heat resistant, machinable, high moisture vapor transmission	Opaque	OK	300 - 356°F 150 - 180°C	Self-extinguishing
PTFE	Biologically and chemically inert, high heat resistant, slippery surface	Opaque	OK	250°F 121°C	None
PVC (Plasticized)	Inert, tough, clear, high chemical resistance	Clear	Melts	110 - 175°F 43 - 80°C	Self-extinguishing
Vinyl-Chloride (Goen, Saran)	Clear, popular as film material	Clear	Melts	130 - 150°F 54 - 66°C	Self-extinguishing
Cellulose Nitrate (Celluloid)	Tough, fairly clear	Clear	Melts	140 - 160°F 60 - 71°C	Fast (explosive)
Polypropylene Film	Clear film material	Clear	OK	260°F 126°C	Slow
Thermosetting Polyester Films (Mylar)	Clear film material	Clear	OK	258°F 121°C	Self-extinguishing

The following are Tradenames: Plexiglass (Rohm & Hass Co.), Lucite & Mylar (E.I. duPont & Co.), Geon (B. F. Goodrich Chem. Co.), Celluloid (Mazzucchelli Celluloide S.p.A.).

Portions of this table courtesy of Modern Plastics Encyclopedia. Most data are from tests by ASTM methods. Tables show averages or ranges. Many properties vary with manufacturer, formulation, and testing laboratory.

*Obtained from a table that lists gas permeability in cc/100 sq. in. per 24 hrs./mil.

Effect of Laboratory Reagents (Routine Storage or Contact Periods)					Gas Permeability of Thin-wall Products*		
Weak Acids	Strong Acids	Weak Alkalies	Strong Alkalies	Organic Solvents	O ₂	N ₂	CO
None	Oxidizing acids attack	None	None	Soluble in aromatic chlorinated hydrocarbons	Low	Very low	High
None	Oxidizing acids attack	None	None	Soluble in aromatic chlorinated hydrocarbons	—	—	—
None	Oxidizing acids attack	None	None	Soluble-ketones, esters, and chlorinated hydrocarbons	Very low	Very low	Low
None	Oxidizing acids attack	None	None	Resistant below 80°C	High	Low	Very high
None	Oxidizing acids attack	None	None	Resistant below 60°C	High	Low	Very high
None	Oxidizing acids attack	None	None	Resistant below 175°C	High	Low	Very high
None	None	None	Slowly attacked	Soluble in chlorinated hydrocarbons—part soluble in aromatics	Very low	Very low	Low
Slight	Oxidizing acids attack	Slight	Slight	Soluble in ketones, esters, aromatic hydrocarbons	Very high	Very low	—
Slight	Decomposes	Slight	Decomposes	Softens in alcohol, Soluble in ketones, esters	Very low	Very low	High
None	Attacked	None	None	Resistant	Very low	Very low	—
None	None	None	None	Resistant	—	—	—
None	None	None	None	Soluble in ketones, esters	Low	—	High
None	None	None	None	Slightly resistant to hydrocarbons, ketones, etc.	Low	—	High
Slight	Decomposes	Slight	Decomposes	Soluble in ketones and esters, softens in alcohol, slightly affected by hydrocarbons	—	—	—
None	Oxidizing acids attack	None	None	Resistant below 175°C	High	Low	Very high
None	None	None	None	Good to excellent	Very low	Very low	Very low

Nomogram for Computing Relative Centrifugal Force

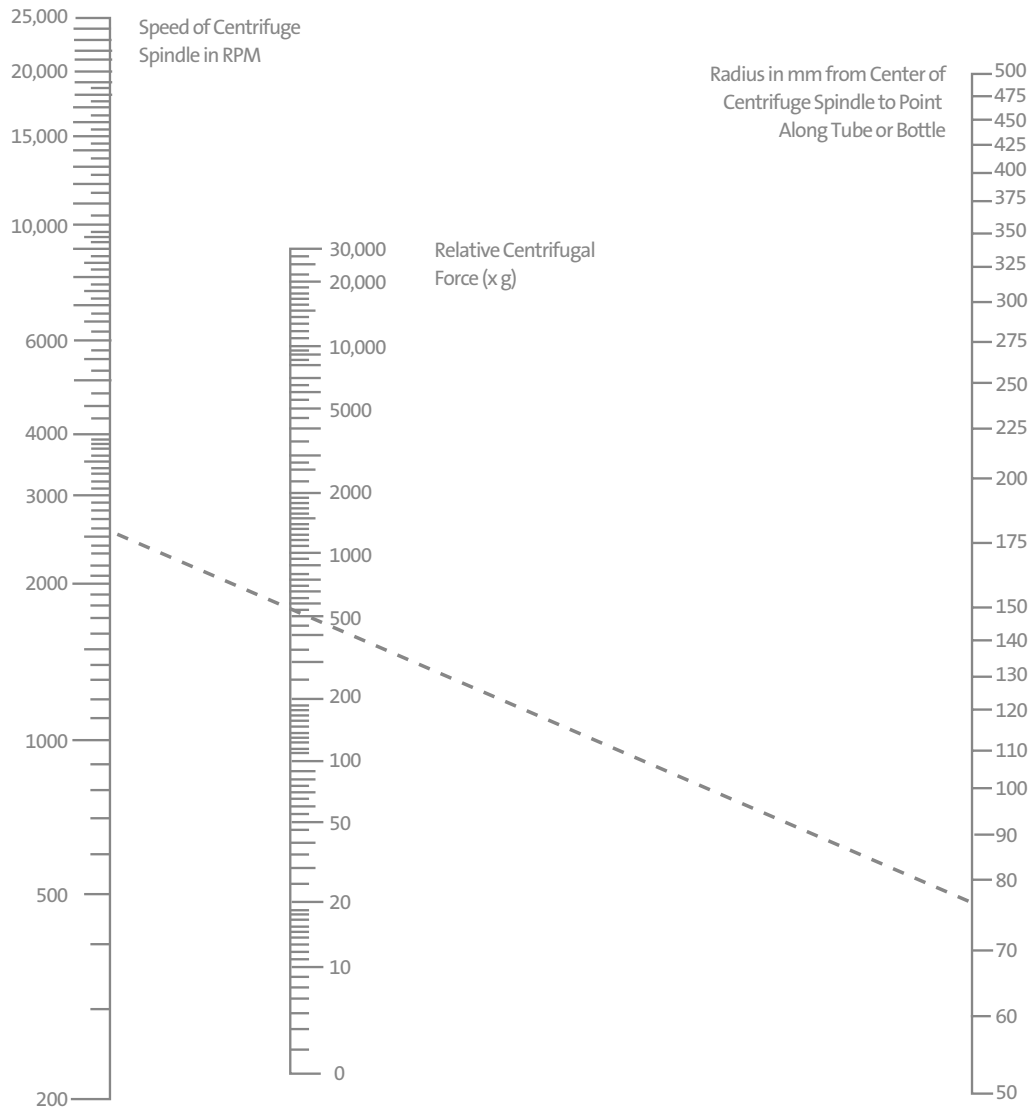

To calculate the RCF value at any point along the tube or bottle, measure the radius, in mm, from the center of the centrifuge spindle to the particular point. Draw a line from the radius value on the right-hand column to the appropriate centrifuge speed on the left-hand column. The RCF value is the point where the line crosses the center column. The nomogram is based on the formula:

$$RCF = (11/17 \times 10^{-7}) RN^2$$

where:

R = Radius in mm from centrifuge spindle to point in tube bottom

N = Speed of spindle in RPM

Catalog Number Index

Cat. No.	Page No.	Cat. No.	Page No.	Cat. No.	Page No.	Cat. No.	Page No.
351006	36	352235	47	353263	38	356521	41
351007	36	352340	37	353292	20	356525	41
351008	36	352350	37	353296	11	356535	41
351029	36	353001	9	353376	11	356543	41
351058	36	353002	9	353377	11	356550	41
351131	23	353003	9	353492	20	356551	41
351143	11	353004	9	353493	20	357469	44
351146	11	353009	3	353494	20	357472	44
351147	11, 22, 27	353014	3	353495	20	357473	44
351151	25	353018	3	353502	21	357474	44
351152	25	353024	3	353503	21	357476	44
351156	27	353025	9	353504	21, 25	357477	44
351157	27	353028	3	353652	15	357486	44
351158	27	353037	9	353653	15	357487	44
351161	29	353043	11	353654	15	357488	44
351162	29	353046	11	353655	15	357489	44
351163	29, 37	353047	11, 22, 27	353671	15	357490	44
351164	29	353072	11	353801	9, 17	357501	43
351172	11	353075	11	353802	9, 17	357506	42, 43
351177	11	353077	11	353803	9, 17	357507	41
351178	11	353078	11	353808	3, 17	357508	42, 43
351181	22	353082	3	353810	3, 17	357515	42
351182	22	353085	13	353813	3, 17	357521	41
351183	22	353086	13	353824	3, 17	357524	43
351185	22	353087	13	353846	11, 17	357525	41
351186	27	353089	13	353847	11, 17, 22, 27	357529	42
351190	38	353090	20	353872	11, 17	357530	42
352001	47	353091	20	353910	11	357535	41
352002	47	353092	20	353916	11	357543	41
352003	47	353093	20	353924	23	357550	41
352006	47	353095	20	353925	23	357551	41
352008	47	353096	20	353928	29	357558	43
352017	47	353097	20	353934	11	357575	43
352018	47	353102	20	353935	11, 22, 27	357600	41
352025	47	353103	20	353936	11	358206	49
352027	47	353104	20	353938	23	P2028	44
352032	47	353107	3	353958	12		
352037	47	353108	3	353961	12		
352045	47	353109	3	353962	12		
352051	47	353110	3	353963	12		
352052	47	353112	3	353988	12		
352053	47	353133	3	354013	37		
352054	47	353135	3	354014	37		
352057	47	353136	3	354015	37		
352058	47	353138	3	354017	37		
352059	47	353139	3	354020	37		
352063	47	353143	5	354104	7		
352070	49	353144	5	354108	7		
352075	49	353180	20	354114	7		
352076	49	353181	20	354118	7		
352090	49	353182	20	354637	6		
352095	49	353219	11	354638	6		
352096	49	353224	11	354639	6		
352097	49	353225	11	355000	3		
352098	49	353226	11, 22, 27	355001	3		
352099	49	353227	11	355467	21		
352196	49	353230	11	356507	41		

Products may not be available in all markets.

official distributor

SZABO-SCANDIC HandelsgmbH
Quellenstraße 110, A-1100 Wien
T. +43(0)1 489 3961-0
F. +43(0)1 489 3961-7
mail@szabo-scandic.com
www.szabo-scandic.com



SZABO SCANDIC

Warranty/Disclaimer: Unless otherwise specified, all products are for research use or general laboratory use only.* Not intended for use in diagnostic or therapeutic procedures. Not for use in humans. These products are not intended to mitigate the presence of microorganisms on surfaces or in the environment, where such organisms can be deleterious to humans or the environment. Corning Life Sciences makes no claims regarding the performance of these products for clinical or diagnostic applications. *For a listing of US medical devices, regulatory classifications or specific information on claims, visit www.corning.com/resources.

Corning's products are not specifically designed and tested for diagnostic testing. Many Corning products, though not specific for diagnostic testing, can be used in the workflow and preparation of the test at the customers discretion. Customers may use these products to support their claims. We cannot make any claims or statements that our products are approved for diagnostic testing either directly or indirectly. The customer is responsible for any testing, validation, and/or regulatory submissions that may be required to support the safety and efficacy of their intended application.

CORNING

Corning Incorporated
Life Sciences

www.corning.com/lifesciences

NORTH AMERICA

t 800.492.1110
t 978.442.2200

ASIA/PACIFIC

Australia/New Zealand

t 61 427286832

Chinese Mainland

t 86 21 3338 4338

India

t 91 124 4604000

Japan

t 81 3-3586 1996

Korea

t 82 2-796-9500

Singapore

t 65 6572-9740

Taiwan

t 886 2-2716-0338

EUROPE

CSEurope@corning.com

France

t 0800 916 882

Germany

t 0800 101 1153

The Netherlands

t 020 655 79 28

United Kingdom

t 0800 376 8660

All Other European Countries

t +31 (0) 206 59 60 51

LATIN AMERICA

grupoLA@corning.com

Brazil

t 55 (11) 3089-7400

Mexico

t (52-81) 8158-8400