

official distributor

SZABO-SCANDIC Handels GmbH  
Quellenstraße 110, A-1100 Wien  
T. +43(0)1 489 3961-0  
F. +43(0)1 489 3961-7  
mail@szabo-scandic.com  
www.szabo-scandic.com



SZABO  
SCANDIC

# Falcon® Product Selection Guide

**FALCON®**

*A Corning Brand*





# Table of Contents

## General Information

Falcon Brand Products . . . . .	3
Ask the Scientist! . . . . .	4
Our Commitment to Quality . . . . .	5

## Falcon® Cultureware

Cell Culture Flasks . . . . .	8
Flasks . . . . .	8
Multi-Flasks . . . . .	10
Flask Caps. . . . .	12
CultureSlides . . . . .	13
Cell Culture Dishes. . . . .	14
Plates and Microplates . . . . .	16
Microplates . . . . .	18
Cell Scrapers. . . . .	19
<i>In Vitro</i> Fertilization Plasticware . . . . .	20
Corning® Primaria™ Cultureware . . . . .	22
Cell Culture Inserts . . . . .	24
Inserts and Companion Plates . . . . .	24
24 Multiwell Insert Systems . . . . .	28
96 Multiwell Insert Systems . . . . .	30
Corning FluoroBlok™ Cell Culture Inserts . . . . .	32
Corning FluoroBlok 24 Multiwell Insert Systems . . . . .	34
Corning FluoroBlok 96 Multiwell Insert Systems . . . . .	36
Laboratory Aids. . . . .	38
Microplates Key Dimensions . . . . .	38
Working Volumes for Tissue Culture Vessels. . . . .	40
Cell Record Worksheet. . . . .	41

## Additional Falcon Labware

Bacteriological Petri Dishes . . . . .	44
Cell Strainers and Containers . . . . .	45
Library Storage Plates. . . . .	46

## Falcon® Pipets and Pipet Controller

Serological Pipets . . . . .	48
Individually Wrapped Serological Pipets . . . . .	49
Bulk-Packaged Serological Pipets . . . . .	50
Aspirating Pipets. . . . .	51
Transfer Pipets . . . . .	52
Pipet Controller. . . . .	53
Replacement Parts. . . . .	53

## Falcon® Tubes

Round-Bottom Tubes . . . . .	56
Conical Tubes . . . . .	58
Laboratory Aids. . . . .	60
Tube Size Identification Chart . . . . .	60
Tube Chemical Resistance Chart . . . . .	61
Characteristics of Falcon Plasticware. . . . .	62
Rotor/Adapter Selection Guide . . . . .	64
Nomogram for Computing Relative Centrifugal Force. . . . .	65

## Index

Catalog Number Index . . . . .	66
--------------------------------	----





## Falcon® Brand Products

Known the world over for the popular “Falcon Tubes”, the Falcon brand has set the standard for high-quality disposable plasticware for more than 50 years. Falcon-branded liquid handling and cell culture products are designed to advance research and are used in laboratories worldwide. Manufactured from advanced bioanalytical-grade resins and extensively tested, Falcon plasticware ensures high quality and consistent, reliable results.

### **Committed to delivering the right product at the right time**

Corning Sales and Service Representatives are specialists who have the training and knowledge to help you make the right purchasing decisions. You can be confident they’ll direct you to the products that deliver the best value while meeting your research needs.

Our Sales Representatives work in close partnerships with our distributors to ensure the availability of all of our products and to keep you up-to-date on new products and technologies. They stay in touch with you and the changing requirements of your research.

Corning Technical Support Representatives have laboratory experience and an in-depth understanding of our products and their applications. Based on their experience, they provide expert assistance in selecting the products that best meet the requirements of your research protocols.

Our Customer Service Representatives provide the information you need to place and process your orders accurately and efficiently. They make sure you get the products you need, when and where you need them, whether they are through one of our authorized distributors or directly through Corning.

Whether you need to place an order or have a special request or concern, depend on Corning Sales and Service Representatives.



## Scientific Support: Ask the Scientist!

Corning Scientific Support can help you succeed in any stage of your experiment. With a broad background in different Life Science disciplines, our support scientists offer valuable help for basic and advanced product support, designing new experiments, using the right products and delivering the necessary product documentation, protocols and certification.

Our free service may save you time and money!

### Scientific Support at a glance:

- ▶ Pre- and after-sales application support
- ▶ Protocol-setup and -optimization
- ▶ Help choosing the right product (e.g. suitable culture surfaces and -formats)
- ▶ Product documentation & information (e.g. protocols, datasheets, guidelines)
- ▶ Product certificates (e.g. certificates of conformity and analysis)
- ▶ Lot-specific information & reservation (e.g. Matrigel®, ECMs, ADME products)
- ▶ Troubleshooting experiments and data
- ▶ Need more? Tell us!!

### We understand you:

- ▶ We are scientists - just as you!
- ▶ We offer extensive product experience
- ▶ We think out-of-the-box and try to find the best solution for you and your experiment
- ▶ Support in English, German and French

### Contact us:

Email: [ScientificSupportEMEA@corning.com](mailto:ScientificSupportEMEA@corning.com)

Phone: Belgium: +31 20 65 57 928 | France: 0800 916 882 | Germany: 0800 101 1153

| Italy: +31 20 65 57 959 | Luxembourg: 0800 916 882 | Nordic: +31 20 65 57 930 |

Portugal: +31 20 65 57 959 | Spain: 900 993 195 | Switzerland (French): 0800 835 446 |

Switzerland (German): 0800 835 429 | The Netherlands: 020 655 79 28 |

UK: 0800 376 8660 | All other European countries: +31 20 65 96 051

Web: [www.corning.com/lifesciences/emea/en/about\\_us/contact\\_us.aspx](http://www.corning.com/lifesciences/emea/en/about_us/contact_us.aspx)







## Our Commitment to Quality

All Falcon® products are manufactured per current Good Manufacturing Practices (cGMP) and ISO 9001 standard. The ISO certification verifies our facilities meet international quality system standards. The quality system is routinely audited by a notified body to ensure a work environment that consistently maintains the highest standards. ISO compliance gives our customers an added level of assurance that Corning is committed to superior quality and continuous product improvement.

Copies of our ISO and quality certificates, please visit [www.corning.com/lifesciences](http://www.corning.com/lifesciences). You can contact our Scientific Support Team at [ScientificSupportEMEA@corning.com](mailto:ScientificSupportEMEA@corning.com).

### Corning facilities and the products they manufacture

#### Durham, North Carolina

EN ISO 9001 and EN ISO 13485 certified and cGMP (21 CFR 820) compliant

- ▶ Falcon Flasks
- ▶ Falcon Vented Caps
- ▶ Falcon Serological Pipets
- ▶ Falcon Aspirating Pipets
- ▶ Falcon Specimen Containers
- ▶ Falcon Cell Strainers
- ▶ Falcon Cell Culture Inserts
- ▶ Falcon Cell Culture Dishes
- ▶ Falcon Multiwell Plates
- ▶ Falcon Assay Plates
- ▶ Falcon Bacteriological Petri Dishes
- ▶ Falcon *In Vitro* Fertilization Plasticware\*
- ▶ Corning® Primaria™ Flasks
- ▶ Corning Primaria Dishes
- ▶ Corning Primaria Plates

#### Renosa, Mexico

ISO 9001 and cGMP (21 CFR 820) Compliant

- ▶ Falcon Conical Tubes
- ▶ Falcon Round-Bottom Tubes

**Warranty/Disclaimer:** Unless otherwise specified, all products are for research use only. Not intended for use in diagnostic or therapeutic procedures. Corning Life Sciences makes no claims regarding the performance of these products for clinical or diagnostic applications.

\*Falcon *In Vitro* Fertilization plasticware is CE marked in compliance with the European Medical Devices Directive 93/42/EEC. Falcon IVF plasticware cleared as US Class II medical devices by the FDA per 21 CFR 884





# Falcon® Cultureware

## Table of Contents

<b>Cell Culture Flasks</b> . . . . .	<b>8</b>
Flasks . . . . .	8
Multi-Flasks . . . . .	10
Flask Caps. . . . .	12
<b>CultureSlides</b> . . . . .	<b>13</b>
<b>Cell Culture Dishes</b> . . . . .	<b>14</b>
<b>Plates and Microplates</b> . . . . .	<b>16</b>
<b>Microplates</b> . . . . .	<b>18</b>
<b>Cell Scrapers</b> . . . . .	<b>19</b>
<b><i>In Vitro</i> Fertilization Plasticware</b> . . . . .	<b>20</b>
<b>Corning® Primaria™ Cultureware</b> . . . . .	<b>22</b>
<b>Cell Culture Inserts</b> . . . . .	<b>24</b>
Inserts and Companion Plates . . . . .	24
24 Multiwell Insert Systems . . . . .	28
96 Multiwell Insert Systems . . . . .	30
Corning FluoroBlok™ Cell Culture Inserts . . . . .	32
Corning FluoroBlok 24 Multiwell Insert Systems . . . . .	34
Corning FluoroBlok 96 Multiwell Insert Systems . . . . .	36
<b>Laboratory Aids</b> . . . . .	<b>38</b>
Microplates Key Dimensions . . . . .	38
Working Volumes for Tissue Culture Vessels. . . . .	40
Cell Record Worksheet. . . . .	41

### Trust Falcon, the first name in cell culture

Falcon Cultureware was the first developed tissue culture-treated plasticware that enabled scientists to grow cells *in vitro*.

# Falcon® Cell Culture Flasks

- ▶ Vacuum-gas plasma tissue culture treatment provides consistent cell attachment, spreading, and growth
- ▶ Choose standard tissue culture, Corning® Primaria™, or not tissue culture-treated polystyrene growth surfaces to meet your individual cell culture requirements
- ▶ Secure stacking provides stability from accidental tips or spills, and protection against contamination (canted neck flasks)
- ▶ Sterilized by gamma irradiation
- ▶ Nonpyrogenic tested to less than 0.1 EU/mL
- ▶ Volumetric graduations and writing patch
- ▶ Vented caps incorporate a 0.2 µm hydrophobic membrane for optimal gas exchange while protecting against contamination
- ▶ Growth area and volume are nominal

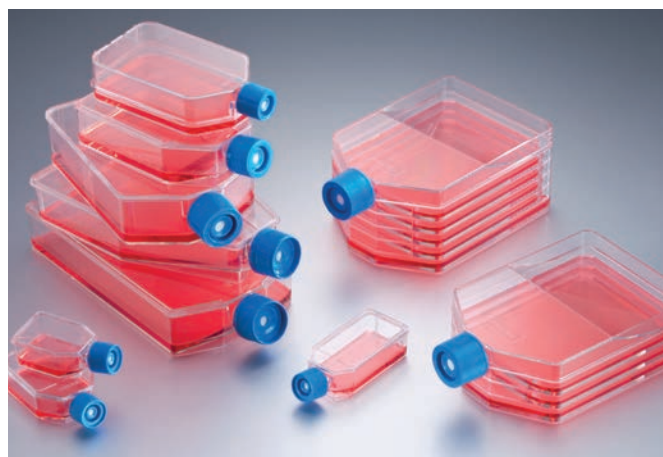

## Tissue culture-friendly packaging

- ▶ Convenient reseal tab on the bag
- ▶ Innovative bag materials that will not scuff or scratch the flask's optical surface
- ▶ Double-wall bags provide increased sterility assurance
- ▶ Medical-style, peel-open bags assure that flask sterility is maintained
- ▶ Recyclable bag material (low density polyethylene)
- ▶ Knife not required for case opening



## 225 cm<sup>2</sup> Flasks

- ▶ Innovative shape permits access to all corners with a pipet or scraper
- ▶ Unique Locking Incubation Position prevents caps from falling off or closing while in the open position
- ▶ Plug Seal or vented cap available
- ▶ Skirted, canted neck adds stability to neck area of flask
- ▶ Large frosted writing area
- ▶ Vertical graduations up to 400 mL
- ▶ 100 mL maximum horizontal working volume line



## Low profile 150 cm<sup>2</sup> Flasks

- ▶ Low profile for efficient stacking and incubator utilization
- ▶ Unique Locking Incubation Position prevents caps from falling off or closing while in the open position
- ▶ Precision engineered cap spins on quickly
- ▶ Innovative shape permits access to all corners with a pipet or cell scraper

## Falcon Cell Culture Flasks Ordering Information

Cat. No.	Surface	Neck Style	Cap Style	Qty/Pk	Qty/Cs
<b>12.5 cm<sup>2</sup> Flask, 25 mL</b>					
353018	Standard TC*	Canted	Plug Seal	10	100
353107	Standard TC	Canted	Vented	10	100
<b>25 cm<sup>2</sup> Flask, 50 mL</b>					
353014	Standard TC	Canted	Plug Seal	20	200
353108	Standard TC	Canted	Vented	20	100
353813	Corning® Primaria™ TC	Canted	Plug Seal	20	200
353808	Corning Primaria TC	Canted	Vented	20	100
<b>25 cm<sup>2</sup> Flask, 70 mL</b>					
353082	Standard TC	Canted	Plug Seal	20	200
353109	Standard TC	Canted	Vented	20	100
353009	Non-TC	Canted	Plug Seal	20	200
<b>75 cm<sup>2</sup> Flask, 250 mL</b>					
353024	Standard TC	Straight	Plug Seal	5	100
353110	Standard TC	Straight	Vented	5	100
353824	Corning Primaria TC	Straight	Plug Seal	5	100
353810	Corning Primaria TC	Straight	Vented	5	100
353135	Standard TC	Canted	Plug Seal	5	60
353136	Standard TC	Canted	Vented	5	60
353133	Non-TC	Canted	Plug Seal	5	60
<b>150 cm<sup>2</sup> Flask, 600 mL</b>					
355000	Standard TC	Canted	Plug Seal	5	40
355001	Standard TC	Canted	Vented	5	40
<b>175 cm<sup>2</sup> Flask, 750 mL</b>					
353028	Standard TC	Straight	Plug Seal	5	40
353112	Standard TC	Straight	Vented	5	40
<b>Bar coded 175 cm<sup>2</sup> Flask, 750 mL</b>					
<i>Compatible with robotic cultivation systems, e.g., The Automation Partnership's SelecT™</i>					
353118	Standard TC	Straight	Vented	5	40
<b>225 cm<sup>2</sup> Flask, 800 mL</b>					
353139	Standard TC	Canted	Plug Seal	5	30
353138	Standard TC	Canted	Vented	5	30

## Falcon Cell Culture Multi-Flasks Ordering Information

Cat. No.	Surface	Neck Style	Cap Style	Qty/Pk	Qty/Cs
<b>525 cm<sup>2</sup> Multi-Flask 3-Layer, up to 50 mL per layer**</b>					
353143	Standard TC	-	Vented	2	12
<b>875 cm<sup>2</sup> Multi-Flask 5-Layer, up to 50 mL per layer**</b>					
353144	Standard TC	-	Vented	1	8

\*TC = Tissue Culture

\*\* For more information on the Multi-Flasks, see page 10

### Tips

- ▶ Use Falcon non-Tissue Culture-treated cell culture flasks for suspension cultures.
- ▶ For enhanced cell performance, Corning® BioCoat™ Flasks are available with pre-applied matrix proteins, and Corning PureCoat™ Flasks are available with synthetic coating (amine and carboxyl). For more information, visit [www.corning.com/lifesciences](http://www.corning.com/lifesciences).

# Falcon® Cell Culture Multi-Flasks

- ▶ Increase productivity by enabling to grow more cells faster and easier
- ▶ 3- or 5-layer formats provide 525 cm<sup>2</sup> and 875 cm<sup>2</sup> cell growth surface area, respectively

## Features

- ▶ Even distribution of media across all layers for homogeneous cell growth
- ▶ Ability to mix cells and reagents in the Falcon Multi-Flask saves time and reduces risk of contamination
- ▶ Flexible design allows to pour or aspirate/recover cells using a pipet
- ▶ Consistent surface treatment for predictable scale-up
- ▶ Lot number printed on each flask for traceability
- ▶ Manufactured in compliance to cGMP standards

## Designed to fit your protocol

Falcon Multi-Flasks offer the same footprint and the same reagent volumes and cell seeding densities per unit area as 175 cm<sup>2</sup> flasks. With the same proven surface treatment as all other Falcon flasks, it simplifies scale up.

## Improves cell culture productivity

Falcon Multi-Flasks deliver a thoughtful design that simplifies cell culture workflow by eliminating multiple steps and reducing the risk of contamination.

- ▶ Pipet access allows to aspirate to replenish media and recover cells without pouring
- ▶ The mixing port enables rapid mixing inside the vessel and allows to add cell suspension, transfection, or other reagents directly to the flask. The port also enables uniform distribution of media and cells to facilitate homogeneous cell growth on all layers.

## More consistent cell growth

Falcon Multi-Flasks' even distribution of media, proven vacuum gas-plasma tissue culture surface treatment, and effective gas exchange all combine to provide an optimal cell culture environment. The result is high cell yield and a homogeneous cell population.



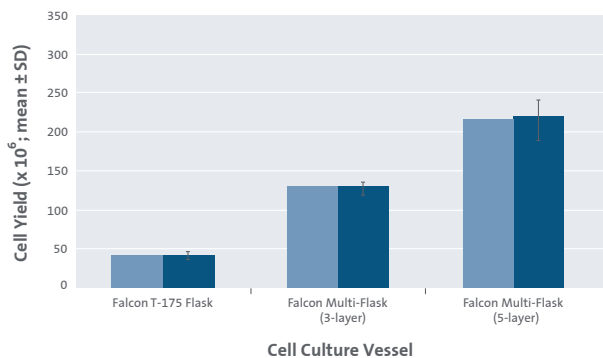

**Predictable scale-up**

Three and five times the number of BHK-21 cells were grown and

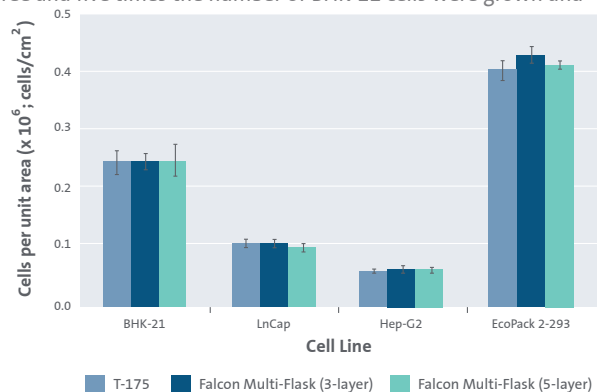

recovered from 3- and 5-layer Falcon® Multi-Flasks compared to T-175 flasks. Expected yield (left panel) was determined using mean cell yield from control T-175 flasks multiplied by three and five times for the 3- and 5-layer Falcon Multi-Flasks, respectively. Cell yield per cm<sup>2</sup> (right panel) was equivalent in 3- and 5-layer Multi-Flasks and T-175 flasks for BHK-21, LnCap, Hep-G2 and EcoPack™2-293 cells.

**Compatible with your cell lines**

Diverse cell lines and primary cultures (with and without serum) can be grown and efficiently recovered from Falcon Multi-Flask cell culture

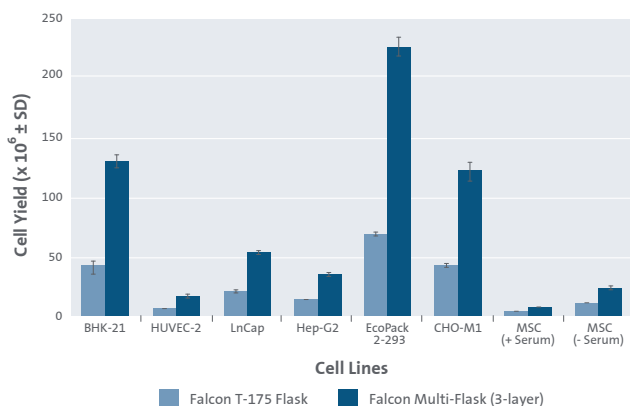

vessels. This graph illustrates the increased cell yield one can obtain from Falcon Multi-Flasks as compared to control T-175 flasks for various cell lines.

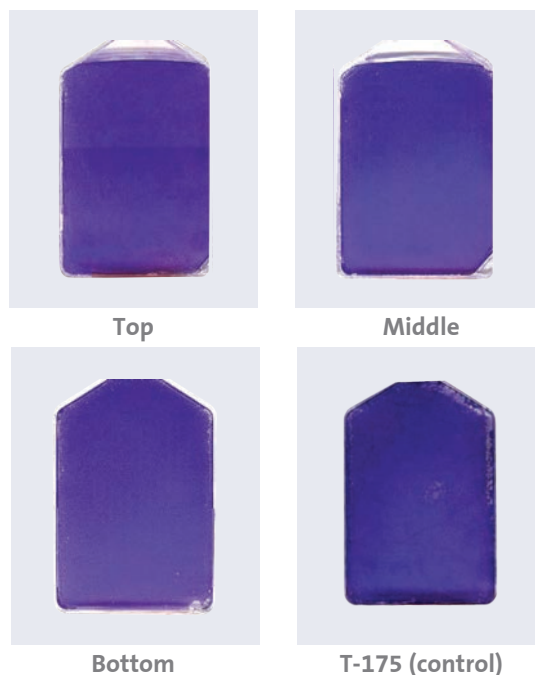

**Consistent cell growth**

This figure illustrates uniform cell growth between layers of Falcon Multi-Flasks. BHK-21 cells grown to >80% confluence in 3-layer Falcon Multi-Flasks and control T-175 flasks were fixed and stained with crystal violet. Control flasks and individual layers of the Falcon Multi-Flasks were cut and scanned.

**Falcon Cell Culture Multi-Flasks Ordering Information**

Cat. No.	Description	Surface Area (cm <sup>2</sup> )	Cap Style	Qty/Cs
<b>Falcon Multi-Flasks</b>				
353143	3-Layer TC-treated	525 cm <sup>2</sup>	Vented	12
353144	5-Layer TC-treated	875 cm <sup>2</sup>	Vented	8

**Tips**

- ▶ Contact your local Corning office for custom coating services.



# Falcon® Flask Caps

A variety of caps to suit your cell culture requirements

## Plug Seal caps

Falcon polyethylene plug seal caps provide a liquid-tight seal when closed and an open-incubation position for reliable gas exchange when partially opened. A reference bar on the outside of the cap is aligned with the “Falcon” on the flask for precise open-incubation conditions.

## Convenient vented caps

- ▶ Ensure consistent gas exchange and minimize contamination
- ▶ Polyethylene caps with an integral, hydrophobic 0.2 µm microporous membrane filter vent allow consistent gas exchange when the caps are in the closed position (see graph). Gases required for cell growth and metabolism pass freely through the vent while microorganisms cannot. Falcon vented caps will not wet out.
- ▶ Vented caps minimize contamination associated with standard open incubation. The vented caps prevent media that can become trapped in a partially opened cap from blocking gas exchange. The caps will not fall off in the incubator because of vibration.



## Falcon Flask Caps Ordering Information

Cat. No.	Description	Qty/Cs
<b>Vented Caps for Falcon Flasks</b>		
354637	For use on 25 cm <sup>2</sup> Flasks	100
354638	For use on 75 cm <sup>2</sup> Flasks	100
354639	For use on 175 cm <sup>2</sup> Flasks	50

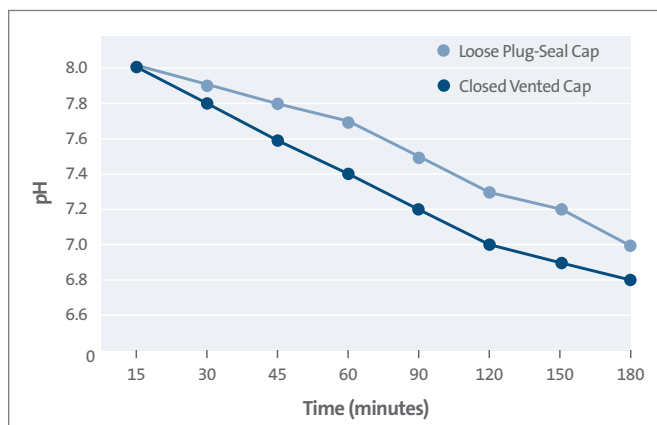

pH equilibration using vented caps after flasks are placed in an incubator (175 cm<sup>2</sup> Flasks, 5% CO<sub>2</sub> incubator)

## Tips

- ▶ Corrugated cardboard boxes are a source of particulates and associated microbial contamination and should not be kept in the tissue culture area. Corning Life Sciences has eliminated corrugated trays from most cases to reduce package waste. You can further reduce contamination due to corrugate by wiping the outside of any package or bag with alcohol or an appropriate disinfectant before putting it under the hood.



# Falcon® CultureSlides

- ▶ Safe and easy chamber removal for microscopic analysis
- ▶ Innovative sealing design

## Falcon CultureSlides for *in situ* analysis

Falcon CultureSlides allow you to culture cells and then analyze them on a glass microscope slide. Cells are grown in a plastic chamber affixed to a specially prepared glass microscope slide.

Cells can be fixed and stained in place without disruption of the cell monolayer. The chamber is easily and safely removed with an easy-to-use, disposable Safety Removal Tool.

## Designed for consistent cell culture results

- ▶ Specially cleaned and triple-rinsed glass slides
- ▶ Performance validated with HEp-2 and BAE cells
- ▶ Tested for 72-hour confluency with MRC-5 and BAE cells

## Features

- ▶ 1.2 mm beveled-edge slide, 25 mm x 75 mm, soda-lime glass
- ▶ Pressure-sensitive, biocompatible, non-migrating, acrylic-adhesive gasket
- ▶ Blue hydrophobic border defines cell culture areas
- ▶ Polystyrene vessel, lid, and tool
- ▶ Supplied with disposable Safety Removal Tool
- ▶ Wells numbered for easy identification
- ▶ Sterile
- ▶ Trays designed for use in incubator
- ▶ Shelf life specified on each package

## Partial list of cells cultured on Falcon CultureSlides

- ▶ Glioblastoma
- ▶ NLBT-2 line
- ▶ HEp-2 cells
- ▶ MRC-5 cells
- ▶ Fibroblasts: human foreskin
- ▶ E6 cells infected with HSV, CMV
- ▶ FS cells infected with HSV, CMV
- ▶ Primary rat skeletal muscle (with Corning® Matrigel® Matrix)
- ▶ Primary ventral spinal cord (with PDL/Laminin)
- ▶ Primary neurons (with Fibronectin, Laminin, Polyornithine, ECM Fragments)
- ▶ Primary bovine aortic endothelium (Fibronectin)
- ▶ PC-12 cells (Polyornithine/Laminin; PDL/Laminin)
- ▶ Primary SC6 rat cells (Collagen)
- ▶ Glial cells (Tenascin)

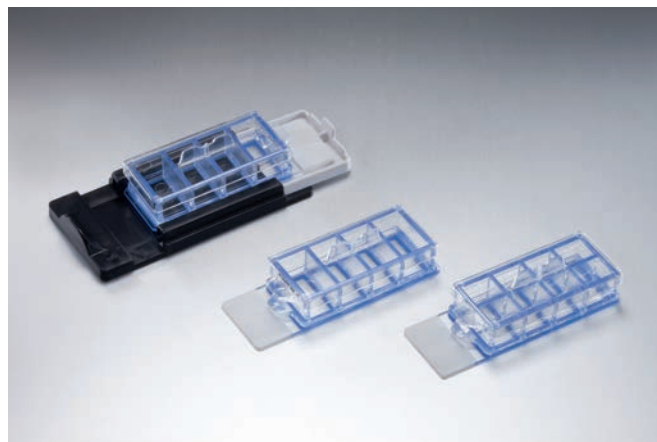

## Simple Vessel Removal for Microscopic Analysis

A simple Safety Removal Tool lifts the plastic vessel off the glass slide. The adhesive gasket remains with the vessel, not on the slide, facilitating further processing or placement of coverslips.

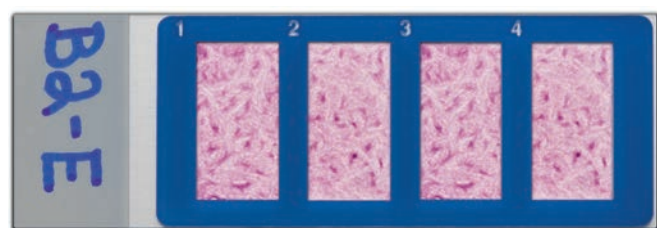

Photograph of primary bovine aortic endothelial cells grown on Falcon CultureSlides and stained with crystal violet. The blue hydrophobic grid defines the cell culture area. A white writing patch provides clear sample identification. Well location numbers etched in the grid are clearly visible.

## Falcon CultureSlides Ordering Information

Cat. No.	Description	Total Volume per Well (mL)	Working Volume per Well (mL)	Qty/ Pk	Qty/ Cs
<b>4 well</b>					
354104	1.7 cm <sup>2</sup>	1.5-1.7	0.7-1.25	12	96
354114	1.7 cm <sup>2</sup>	1.5-1.7	0.7-1.25	12	24
<b>8 well</b>					
354108	0.7 cm <sup>2</sup>	0.7-0.75	0.3-0.5	12	96
354118	0.7 cm <sup>2</sup>	0.7-0.75	0.3-0.5	12	24

## Tips

- ▶ For enhanced cell performance, Corning BioCoat™ CultureSlides are available with pre-applied matrix proteins. For more information, visit [www.corning.com/lifesciences](http://www.corning.com/lifesciences)

# Falcon® Cell Culture Dishes

- ▶ Flat, optically clear polystyrene surfaces for distortion-free microscopic visualization of cells
- ▶ Uniform surface chemistry created by vacuum-gas plasma treatment promotes cell attachment
- ▶ Improved handling of small dishes with the unique Easy-Grip design
- ▶ Nonpyrogenic
- ▶ Sterilized by gamma irradiation
- ▶ Packaged in peel-open, medical-style bags
- ▶ Crystal-grade virgin polystyrene
- ▶ Standard Tissue Culture (TC), Corning® Primaria™ surface treatment and non-TC-treated polystyrene available

## Designed for cell culture

- ▶ Flat, distortion-free optics
- ▶ Lids designed for optimal gas exchange
- ▶ Stacking rings allow for easier stacking and handling
- ▶ Vacuum-gas plasma treatment permanently and consistently modifies the cell growth surface
- ▶ Standard tissue culture surface is hydrophilic and contains a variety of negatively charged functional groups that support cell attachment and spreading
- ▶ Corning Primaria tissue culture surface additionally incorporates nitrogen-containing functional groups and has been shown to support improved attachment, spreading, and differentiation of some cell types

## Cell performance tests ensure consistent results

A sensitive clonogenic assay<sup>1</sup> using MRC-5 cells, a diploid human fibroblast line, is used to validate the manufacturing process for each Falcon tissue culture product. Routine testing of standard tissue culture products is performed by testing growth to confluency at 72 hours with MRC-5 cells. The surface chemistry of each lot of Corning Primaria products is confirmed by Electron Scanning for Chemical Analysis (ESCA).

## Reference

1. Freshney, R.I., Culture of animal cells: a manual of basic technique, 2d ed., Wiley-Liss, London, p. 83 (1987).

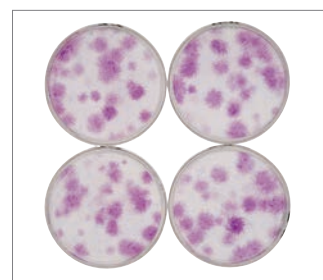

### Falcon Easy-Grip Dishes

The unique design and frosted rim improve the handling of small dishes. The ability to pick up a small dish conveniently without accidentally removing the lid allows you to work faster and improves aseptic manipulation.

### Tissue Culture Process Validation

Each Falcon tissue culture product is developed using a sensitive clonogenic assay<sup>1</sup>. Shown here is a 35 mm dish with MRC-5 cells stained with crystal violet.

### Falcon Cell Culture Dishes Ordering Information

Cat. No.	Actual Coating	Actual Dimensions (mm)	Growth Area (cm <sup>2</sup> )	Working Volume (mL)	Qty/Pk	Qty/Cs
<b>35 x 10 mm Easy-Grip</b>						
353001	Standard TC*	40.28 O.D. x 6.17	11.78	2.5-3.0	20	500
353801	Corning Primaria TC	40.28 O.D. x 6.17	11.78	2.5-3.0	20	200
<b>60 x 15 mm Standard**</b>						
353002	Standard TC	54.81 O.D. x 13.26	21.29	6.0-7.0	20	500
353802	Corning Primaria TC	54.81 O.D. x 13.26	21.29	6.0-7.0	20	200
<b>60 x 15 mm Easy-Grip</b>						
353004	Standard TC	52.10 O.D. x 13.13	19.5	6.0-7.0	20	500
<b>100 x 20 mm Standard</b>						
353003	Standard TC	89.43 O.D. x 19.18	58.95	16.0-17.5	20	200
353803	Corning Primaria TC	89.43 O.D. x 19.18	58.95	16.0-17.5	20	200
<b>150 x 25 mm Gridded (20 mm grid molded in base)</b>						
353025	Standard TC	142.57 x 24.77	156.36	45.0-50.0	10	100
<b>60 x 15 mm Center-Well Organ Culture**</b>						
353037	Standard TC	54.84 O.D. x 13.5	62.89	-	20	500

\* TC = Tissue Culture

\*\* For qualified In Vitro Fertilization Dishes, see page 20

### Related Products

- ▶ Corning Primaria Cultureware . . . . . 22
- ▶ Falcon IVF Products . . . . . 20
- ▶ Non-Tissue Culture-treated Dishes (bacteriological grade) . . . . . 44

### Tips

- ▶ If you work with 35 mm or 60 mm dishes, try our Falcon Easy-Grip Dishes.
- ▶ Corning Life Sciences offers dishes for *in vitro* fertilization that are certified nonembryotoxic. Certification is based on a statistically relevant sample taken from each lot that is tested for embryotoxicity. See page 20 for additional information.
- ▶ Not treated polystyrene products are equivalent to bacteriological-grade polystyrene products.
- ▶ For enhanced cell performance, Corning BioCoat™ Dishes are available with pre-applied matrix proteins and Corning PureCoat™ Dishes are available with synthetic coating. For more information, visit [www.corning.com/lifesciences](http://www.corning.com/lifesciences).

# Falcon® Plates

- ▶ Unique labyrinth lid, condensation rings, and deep-well design control contamination, reduce evaporation, and minimize edge effects
- ▶ Reliable vacuum-gas plasma tissue culture treatment provides well-to-well and plate-to-plate consistency

## Reliable growth surfaces assure consistent cell performance

All tissue culture treatments render polystyrene hydrophilic and result in the incorporation of a variety of anionic functional groups that support cell culture. To ensure reproducible results and conditions, all Falcon tissue culture treatment is performed in a vacuum chamber.

Corning® Primaria™ tissue culture treatment additionally incorporates nitrogen-containing functional groups that have been shown to improve attachment and spreading of some cell types.

Falcon Non-Tissue Culture-treated plates have a more hydrophobic surface and show reduced cell attachment.

## Cell tests ensure consistent results

A sensitive clonogenic assay<sup>1</sup> using MRC-5 cells, a diploid human fibroblast line, is used to validate the manufacturing process for each Falcon and Tissue Culture (TC) product. Routine testing of standard TC products is performed by testing growth to confluency at 72 hours with MRC-5 cells. The surface chemistry of each lot of Corning Primaria products is confirmed by Electron Scanning for Chemical Analysis (ESCA).

## Reference

1. Freshney, R.I., Culture of animal cells: a manual of basic technique, 2d ed., Wiley-Liss, London, p. 83 (1987).

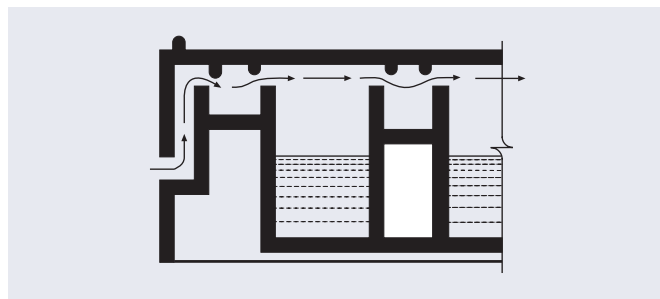
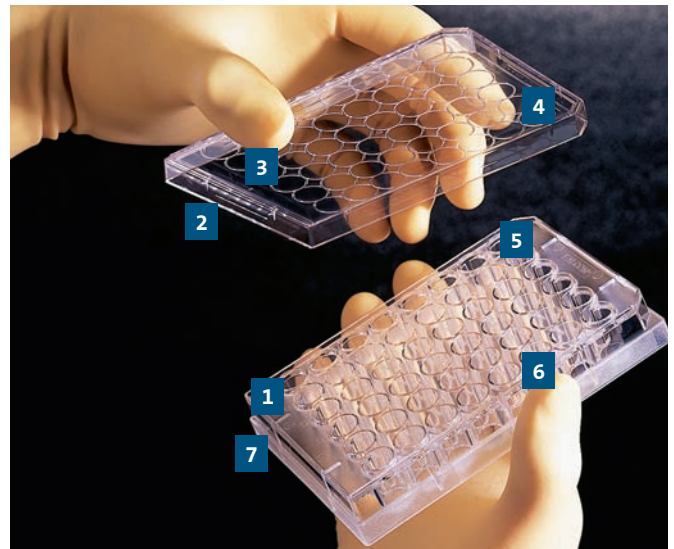

### Low-Evaporation Lid

An innovative labyrinth air-passage system provides a tortuous path for gas exchange across Falcon plates. This unique feature reduces evaporation and minimizes contamination.

1. Alphanumeric well identification
2. One-way lid
3. Condensation rings
4. Low-evaporation labyrinth lid

5. Deep wells
6. Serrated gripping panels
7. Writing patch

# Falcon® Plates and Microplates

- ▶ Versatility of plate colors to suit various detection methods
- ▶ Crystal-grade virgin polystyrene
- ▶ Sterilized by gamma irradiation
- ▶ Nonpyrogenic
- ▶ Non-treated polystyrene, standard tissue culture (TC), and Corning® Primaria™ surface treatments available
- ▶ Convenient, peel-open medical-style packaging for individual product presentation
- ▶ Individual and Ready-Stack (RS) trays are PET (Code 1) and recyclable
- ▶ Falcon 96, 384, and 1536 well microplates are compatible with automation systems and meet standard ANSI/SBS footprint dimensions for microplates
- ▶ Growth area and volume are nominal - See page 40 for more details

## Applications

- ▶ Ion channel/Calcium flux (FLIPR)
- ▶ GPCR (Act/Inact)
- ▶ Cell cytotoxicity
- ▶ Cell proliferation
- ▶ Cell adhesion
- ▶ Differentiation (primary cells)
- ▶ Cell migration
- ▶ Reporter gene
- ▶ Neurite outgrowth

## Falcon Plates and Microplates Ordering Information

Cat. No.	Surface	Growth Area (cm <sup>2</sup> )	Well Volume (mL)	Qty/Pk	Qty/Cs
<b>6 well plates, flat-bottom with lid</b>					
353046	Standard TC*	9.6	15.5	1/tray	50
353224	Standard TC	9.6	15.5	6/bag	36
353934	Standard TC	9.6	15.5	10/RS tray	60
353846	Corning Primaria TC	9.6	15.5	1/tray	50
351146	Non-TC-treated	9.6	15.5	1/tray	50
<b>12 well plates, flat-bottom with lid</b>					
353043	Standard TC	3.8	6.0	1/tray	50
353225	Standard TC	3.8	6.0	6/bag	36
351143	Non-TC-treated	3.8	6.0	1/tray	50
<b>24 well plates, flat-bottom with lid</b>					
353047	Standard TC	2.0	3.5	1/tray	50
353226	Standard TC	2.0	3.5	6/bag	36
353935	Standard TC	2.0	3.5	10/RS tray	60
353847	Corning Primaria TC	2.0	3.5	1/tray	50
351147	Non-TC-treated	2.0	3.5	1/tray	50
<b>48 well plates, flat-bottom with lid</b>					
353078	Standard TC	0.75	1.4	1/tray	50
353230	Standard TC	0.75	1.4	6/bag	36
351178	Non-TC-treated	0.75	1.4	1/tray	50
<b>96 well microplates, flat-bottom with lid</b>					
353072	Standard TC, clear	0.32	0.37	1/tray	50
353075	Standard TC, clear	0.32	0.37	5/bag	50
353936	Standard TC, clear	0.32	0.37	14/RS tray	84
353916	Standard TC, clear	0.32	0.37	25/bag	100
353296	Standard TC, white	0.32	0.37	5/bag	100
353376	Standard TC, black	0.32	0.37	8/bag	32
353377	Standard TC, white/clear	0.32	0.37	8/bag	32
353219	Standard TC, black/clear	0.32	0.37	8/bag	32
353872	Corning Primaria TC	0.32	0.37	1/tray	50
351172	Non-TC-treated	0.32	0.37	1/tray	50
<b>96 well microplates, U-bottom with lid (except as indicated)</b>					
353077	Standard TC	0.36	0.32	1/tray	50
353227	Standard TC	0.36	0.32	5/bag	50
351177	Non-TC-treated	0.36	0.32	1/tray	50
353910	Non-TC-treated, no lid, non-sterile	0.36	0.32	5/bag	50

For 96 well microplate dimensions, please see page 38



# Falcon® Microplates

- ▶ Ideal for use in high throughput systems
- ▶ Falcon 384 and 1536 well microplates are compatible with automation systems and meet standard ANSI/SBS footprint dimensions for microplates

## Falcon Microplates Ordering Information

Cat. No.	Description	Qty/Pkg	Qty/Cs
<b>384 well microplates, flat-bottom with lid (except as indicated)</b>			
Growth Area: 10 mm <sup>2</sup> , small volume: 2,7 mm <sup>2</sup>			
Well Volume: 130 µL, small volume: 28 µL			
353961	Standard TC, clear	5/bag	50
353988	Standard TC, white	5/bag	50
353380	Standard TC, white, small volume, no lid	10/bag	80
353378	Standard TC, black	5/bag	50
353379	Standard TC, black, small volume, no lid	10/bag	80
353963	Standard TC, white/clear	5/bag	50
353962	Standard TC, black/clear	5/bag	50
<b>1536 well microplates, flat-bottom, no lid</b>			
Growth Area: 2,3 mm <sup>2</sup>			
Well Volume: 12,6 µL			
353381	Standard TC, white, high-base	15/bag	60
353382	Standard TC, black, high-base	15/bag	60
353384	Standard TC, white/clear, high-base	15/bag	60
353386	Standard TC, white/clear, low-base	15/bag	60
353383	Standard TC, black/clear, high-base	15/bag	60
353385	Standard TC, black/clear, low-base	15/bag	60
<b>Low-evaporation lids</b>			
353836	4 mm ultra-low profile polystyrene for 96, 384, 384 small volume, and 1536 well microplates, sterile	5/bag	100
353958	6 mm polystyrene, for 96 and 384 well microplates, non-sterile	5/bag	100

For microplate dimensions, please see page 38

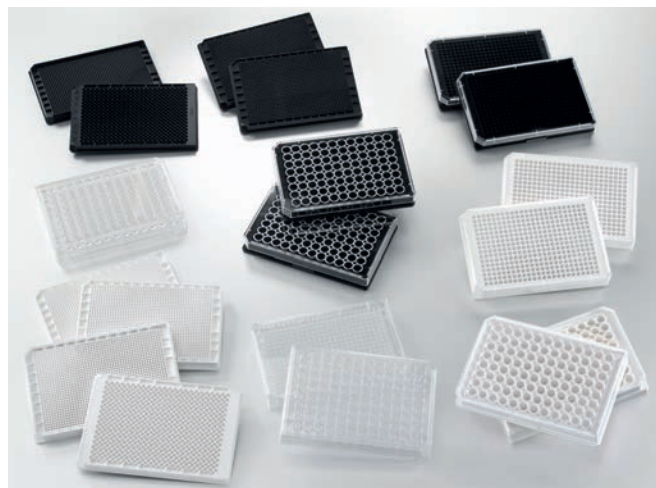

### Tips

- ▶ Contact your materials management department to find out about PET recycling in your community.
- ▶ For information on bar coding services, contact your local Corning office or visit [www.corning.com/lifesciences](http://www.corning.com/lifesciences).



# Falcon® Cell Scrapers

- ▶ The improved Falcon Cell Scrapers have been thoughtfully designed to provide maximum accessibility to the growth surfaces in a variety of culture vessels
- ▶ Cross-ribbed polystyrene handle provides greater rigidity to ensure better control while scraping cells
- ▶ Flexibility of the joint between the blade and handle improves ease of access into the neck of a flask or roller bottle

- ▶ Highly compliant thermoplastic elastomer (TPE) blade pivots to provide multiple angles to remove cells from the entire growth surface
- ▶ Available in four sizes—choose the blade and handle length to best accommodate your needs
- ▶ Supplied individually in peel-open, medical-style packaging for sterile presentation

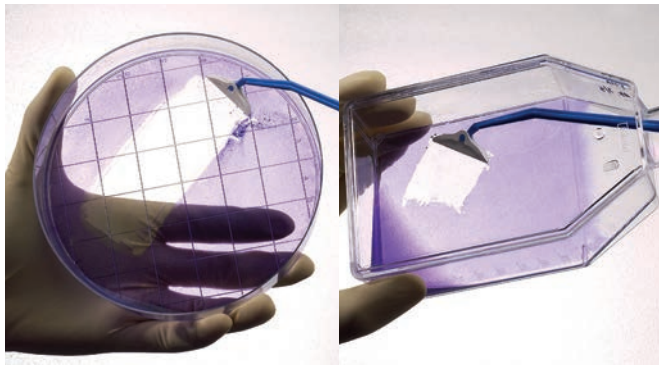
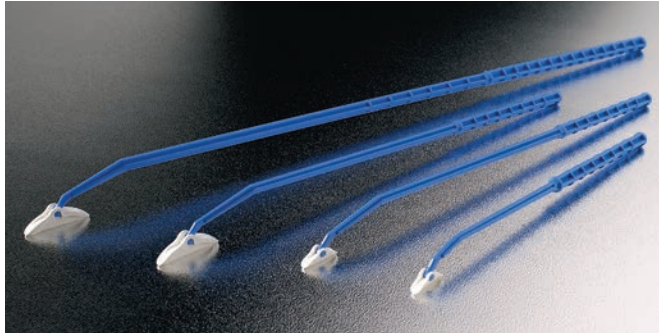

The improved Falcon Cell Scraper (Cat. No. 353089) has a larger blade to increase cell scraping efficiency in both Falcon Dishes and 75 cm<sup>2</sup> Flasks.

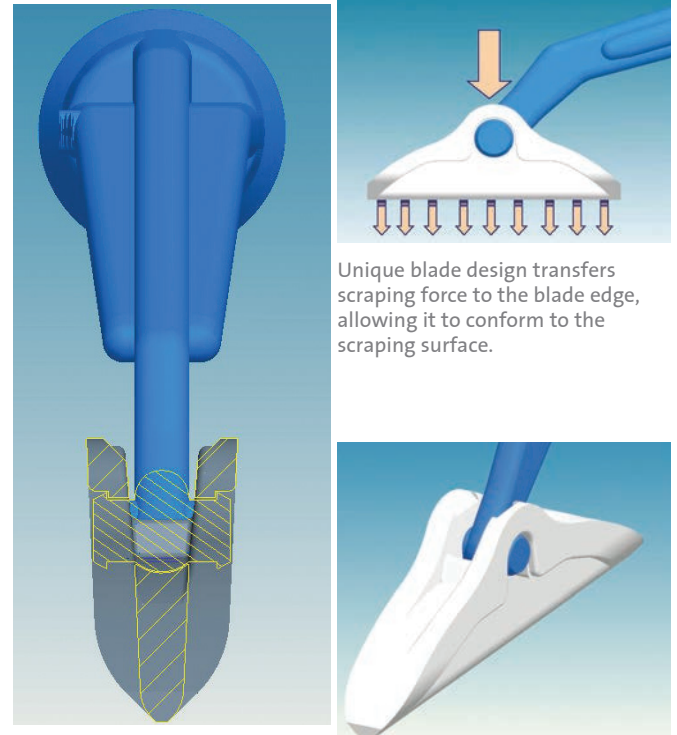

- Larger handle diameter for better gripping.
- Sharper scraping edge
- More compliant blade material

“Barbs” ensure blade remains attached to handle.

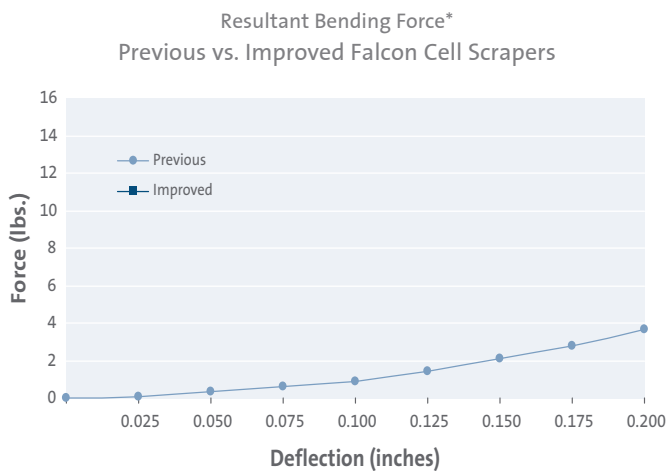

Force required to deflect a simply supported 5” portion of the handle 2.5” distal to the handle section: resultant = (‘X’ force) (‘Y’ force)

## Falcon Cell Scrapers Ordering Information

Cat. No.	Description	Qty/Pk	Qty/Cs
<b>1.8 cm TPE Blade</b>			
353085	18 cm polystyrene handle for use with Falcon 25 cm <sup>2</sup> Flasks	1	100
353086	25 cm polystyrene handle for use with Falcon 75 cm <sup>2</sup> Flasks	1	100
<b>3.0 cm TPE Blade</b>			
353089	25 cm polystyrene handle for use with Falcon Dishes and 75 cm <sup>2</sup> Flasks	1	100
353087	40 cm polystyrene handle for use with large Falcon Flasks	1	100

## Falcon® *In Vitro* Fertilization Plasticware

- ▶ Qualified plasticware for *in vitro* fertilization (IVF) and assisted reproduction techniques
- ▶ US Food and Drug Administration (FDA) cleared Class II medical device
- ▶ Manufactured in accordance with FDA Quality System Regulation 21 CFR Part 820 (cGMP)
- ▶ CE marked in compliance with the European Medical Devices Directive 93/42/EEC
- ▶ Manufactured under EN ISO 9001 and EN ISO 13485 quality standards



### Qualified Falcon IVF products

Falcon *In Vitro* Fertilization (IVF) products are the first plasticware available that is certified sterile, nonpyrogenic and nonembryotoxic. These qualified products save you time and expense in complying with the College of American Pathologists (CAP) and American Fertility Society (AFS) recommended standards for IVF labs. IVF Products are classified by the US FDA as Class II medical devices per the 21 CFR Part 884. These devices are classified as Medical Devices Class IIa according to the Medical Devices Directives 93/42/EEC.

### Features

- ▶ Nonembryotoxic
- ▶ Nonpyrogenic tested to less than 0.1 EU/mL or 5 EU/device
- ▶ Tissue Culture-treated for a consistent hydrophilic surface
- ▶ IVF Low Wall Dish for ICSI procedure specifically are non-TC-treated for facilitated media droplet creation
- ▶ Sterilized by gamma irradiation to a Sterility Assurance Level (SAL) of  $10^{-6}$
- ▶ Packaged in peel-open, medical-style packaging
- ▶ Multi-unit bags have reseal tabs

## Mouse embryo testing

Each lot of Falcon IVF product is tested for embryotoxicity using the 1-cell mouse embryo assay. Mouse embryos are isolated at the 1-cell stage from B<sub>6</sub>C<sub>3</sub>F<sub>1</sub> females following super ovulation with gonadotropin and mating with B<sub>6</sub>D<sub>2</sub>F<sub>1</sub> males. Falcon IVF products are tested using both a direct and indirect test method. In the direct assay, the embryos are cultured directly in the IVF labware. For the indirect assay, culture media is incubated in the IVF labware for 24 hours at 37°C. The incubated media is then transferred to a culture plate and the 1-cell mouse embryo assay is performed. Products are deemed nonembryotoxic if they support the growth of more than 75 percent of the embryos to the expanded and/or hatched blastocyst stage.

In conjunction with embryologists, Corning designed an innovative 4 well plate to improve manipulation of ova and embryos. A unique lid reduces the risk of contamination and minimizes evaporation by providing access to two wells at a time, while two remain covered. The wells are numbered and a large writing patch allows clear sample identification. Plates are packaged in individual peel-open trays for sterile presentation.

Falcon IVF dishes and 4 well plates are manufactured from virgin crystalline polystyrene tested for USP Class VI cytotoxicity. They have flat, optically clear surfaces for optimum manipulation and observation of ova and embryos. Lids were designed for aseptic manipulation and consistent venting to maintain humidification (except for the low wall dish designed with a tight fit lid).

## Falcon Low Wall Dish

Non-Tissue Culture-treated Falcon Low Wall Dish can be utilized in the ICSI (IntraCytoplasmic Sperm Injection) procedure. This 50 mm dish has many of the same features as the other IVF products except the dish is non-Tissue Culture-treated (non-wettable) for optimal media droplet consistency.

This specific Falcon dish is also a low wall dish making the micro-manipulations of the procedure performed easier. This product is packaged in individually sealed blister compartments so one dish can be accessed at a time and the remaining ones can be kept protected. Procedures requiring long term incubation are not recommended in the Falcon IVF Low Wall Dish due to the tight lid fit which results in low gas exchange rates.

## Intended Use:

Falcon IVF devices (353652, 353653, 353654 and 353655) are sterile, nonpyrogenic, embryotoxicity tested, single-use plasticware intended to prepare, store, manipulate or transfer human gametes or embryos for *in vitro* fertilization or other assisted reproduction procedures.

## Falcon *In Vitro* Fertilization Plasticware Ordering Information

Cat. No.	Description	Qty/Pk	Qty/Cs
<b>Low-Wall Dish, 50 x 9 mm</b>			
353655	Well Area: 18.3 cm <sup>2</sup> Height: 8.6 mm	4	100
<b>IVF Round Dish, 60 x 15 mm</b>			
353652	Well Area: 21.29 cm <sup>2</sup> Well Vol.: 23.0 mL	20	500
<b>IVF One Well Dish, 60 x 15 mm</b>			
353653	Well Area: 2.45 cm <sup>2</sup> Well Vol.: 2.5 mL Total Vol.: 20 mL	20	500
<b>IVF Four well Plate, 17 x 11 mm</b>			
353654	Well Area: 1.39 cm <sup>2</sup> Well Vol.: 1.8 mL	1	100

*Note: The lids of the Falcon IVF Products are not certified nonembryotoxic*



Individual certificates, containing actual test results, are available for each lot by contacting Technical Support or visiting [www.corning.com/lifesciences](http://www.corning.com/lifesciences) after you receive your order.

# Corning® Primaria™ Cultureware

- ▶ Unique nitrogen-containing tissue culture surface chemistry
- ▶ Improves attachment, spreading, and growth for many primary cells or cell lines
- ▶ Crystal-grade polystyrene modified by proprietary vacuum-gas plasma treatment process
- ▶ Stable, permanent surface modification
- ▶ Optically clear
- ▶ No special storage required
- ▶ Samples from each lot of Corning Primaria products are analyzed by Electron Scanning for Chemical Analysis (ESCA)
- ▶ Packaged in red color-coded, peel-open, medical-style packages
- ▶ Sterilized by gamma irradiation
- ▶ Nonpyrogenic tested to less than 0.1 EU/mL

## Unique surface chemistry for enhanced cell culture

Consistent cell culture conditions are required for reproducible research results. In the manufacture of all cell cultureware surfaces, hydrophobic polystyrene is permanently rendered hydrophilic to support cell attachment and spreading<sup>1,2,3</sup>. The consistency of this surface depends on the treatment method used.

Many manufacturers have long used atmospheric plasma treatments (i.e., corona) to create hydrophilic surfaces. In corona treatment, a high-voltage discharge creates a reactive gas plasma above the growth surface of the vessel. In this process, the highly interactive gas plasma mixture is created from ambient air. The consistency of the treatment surface can, therefore, be compromised by day-to-day environmental changes.

At Corning Life Sciences, molded polystyrene vessels are placed in a chamber where a partial vacuum is created. A vacuum-gas plasma treatment is fed into the chamber to create a number of negatively charged functional groups on the surface of the polystyrene vessels. The enclosed, highly controlled environment prevents contamination from the ambient air, ensuring a pure and consistent treatment surface.

A major research investment resulted in the development of this unique vacuum-gas plasma process used to produce both Corning Primaria and traditional tissue culture (TC) surfaces on Falcon® Dishes, Flasks, and Plates. The gases used to manufacture Corning Primaria contain both oxygen and ammonia, resulting in the incorporation in the surface of a variety of nitrogen-containing functional groups in addition to the negatively charged oxygen-containing groups found on traditional TC surfaces.

The incorporation of nitrogen-containing cations has been correlated to attachment and spreading of primary endothelial cells in a clonal cell-growth assay<sup>4</sup>. The complex surface on Corning Primaria Cultureware is homogeneous and stable and has been in use by researchers for over two decades to improve attachment and differentiation of a variety of cell types. For example, cell biologists have used Corning Primaria for cultivating hepatocytes<sup>5,6</sup>, neuronal cells<sup>7</sup>, and other endothelial cells<sup>8</sup>.

The surface chemistry of Corning Primaria products is confirmed by Electron Scanning for Chemical Analysis (ESCA).

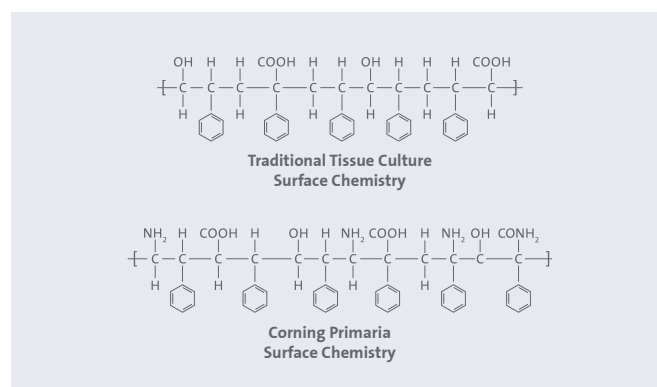

Note: At pH 7, carboxy groups may be slightly dissociated and assume a negative (anionic) charge. Amine groups may protonate and assume a positive charge (cationic).

## A partial list of cell types cultured on Corning Primaria Cultureware

- ▶ Hepatocytes<sup>5,6,9,18</sup>
- ▶ Transfected COS-7<sup>10</sup>
- ▶ Transfected HEK-293<sup>12</sup>
- ▶ CHO<sup>13</sup>
- ▶ Primary Cardiac Myocytes<sup>15</sup>
- ▶ Primary SMC<sup>14</sup> and Skeletal Muscle Cells<sup>16</sup>
- ▶ Osteoblasts<sup>17</sup>
- ▶ Neuronal Cells<sup>7</sup>
- ▶ Endothelial Cells<sup>8</sup>



## Corning® Primaria™ Cultureware Ordering Information

Cat. No.	Actual Dimensions (mm)	Actual Growth Area (cm <sup>2</sup> )	Working Volume (mL)	Qty/ Pk	Qty/ Cs
<b>Dishes</b>					
<b>35 x 10 mm Easy-Grip</b>					
353801	40.28 O.D. x 6.17	11.78	2.5-3.0	20	200
<b>60 x 15 mm Standard</b>					
353802	54.81 O.D. x 13.26	21.29	6.0-7.0	20	200
<b>100 x 20 mm Standard</b>					
353803	89.43 O.D. x 19.18	58.95	16.0-17.5	20	200

Cat. No.	Description	Growth Area (cm <sup>2</sup> )	Total Volume (mL)	Qty/ Pk	Qty/ Cs
<b>Flasks</b>					
<b>25 cm<sup>2</sup> with canted neck</b>					
353813	Plug Seal Caps	25	50	20	200
353808	Vented Caps	25	50	20	100
<b>75 cm<sup>2</sup> with straight neck</b>					
353824	Plug Seal Caps	75	250	5	100
353810	Vented Caps	75	250	5	100

Cat. No.	Growth Area (cm <sup>2</sup> )	Working Volume (mL)	Qty/ Pk	Qty/ Cs
<b>Plates</b>				
<b>6 well Plate with lid</b>				
353846	9.6	15.5	1	50
<b>24 well Plate with lid</b>				
353847	2.0	3.5	1	50
<b>96 well Microplate with lid, flat-bottom</b>				
353872	0.32	0.37	1	50

## References

- Ertel, S., et al., Endothelial cell growth on oxygen-containing films deposited by the radio-frequency plasmas: the role of surface carbonyl groups. *Biomater. Sci.: Polym. Ed.* 3:163 (1991).
- Curtis, A.S.G., et al., Substrate hydroxylation and cell adhesion. *J. Cell Sci.* 86:9 (1986).
- Ramsey, W.S., et al., Surface treatments and cell attachment. *In Vitro* 20:802 (1984).
- Chilkoti, A., et al., Investigating the relationship between surface chemistry and endothelial cell growth: partial least-squares regression of the static secondary ion mass spectra of oxygen-containing plasma-deposited films. *Analytical Chemistry* 67:2883 (1995).
- Boisclair, Y.R., et al., Role of the Suppressor of Cytokine Signaling-3 in the Mediating the Inhibitory Effects of Interleukin-1b on the Growth Hormone-dependent Transcription of the Acid-labile Subunit Gene in Liver Cells. *J. Biol. Chem.* 275(6):3841 (2000).
- Braun, J.R., et al., The Major Subunit of the Asialoglycoprotein Receptor Is Expressed on the Hepatocellular Surface in Mice Lacking the Minor Receptor Subunit. *J. Biol. Chem.* 271(35):21160 (1996).
- Holgado-Madruga, M., et al., Grb2-associated binder-1 mediates phosphatidylinositol 3-kinase activation and the promotion of cell survival by nerve growth factor. *PNAS USA* 94:12419 (1997).
- Silverman, D.J., et al., Primary isolation of human umbilical vein endothelial cells on a surface-modified tissue culture dish. *BDL Monograph* (1986).
- Pawar, A., et al., Unsaturated Fatty Acid Regulation of Peroxisome Proliferator-activated Receptor Activity in Rat Primary Hepatocytes, *J. Biol. Chem.* 278(38):35931(2003).
- Eisenhaure, T., et al., The Rho Guanine Nucleotide Exchange Factor Lsc Homo-oligomerizes and is Negatively Regulated through Domains in its Carboxyl Terminus That Are Absent in novel Splenic Isoforms, *J. Biol. Chem.* 278:(33):30975(2003).
- Nau, G., et al., Human macrophage activation programs induced by bacterial pathogens. *PNAS* 99:1503(2002).
- Hearn, M., et al., A Drosophila dopamine 2-like receptor: Molecular characterization and identification of multiple alternatively spliced variants. *PNAS* 99:14554(2002).
- Ludeman M.J., et al., Regulated Shedding of PAR1-N terminal Exodomain from Endothelial Cells. *J. Biol. Chem.* 279(18):18592(2004).
- Zhuang D., et al., Nitric Oxide attenuates insulin-or IGF-1 stimulated aortic smooth muscle cell motility by decreasing H2O2 levels: essential role of cGMP. *Am. J. Physiol. Heart. Circ.* 286:H2103(2004).
- Doi K., et al., Clinical characteristics relevant to myocardial cell apoptosis: analysis of pericardial fluid. *Interactive Cardiovascular and Thoracic Surgery* 3:359(2004).
- Rieusset J. et al., Suppressor of Cytokine Signaling 3 Expression and Insulin Resistance in Skeletal Muscle of Obese and Type 2 Diabetic Patients. *Diabetes* 53:2232(2004).
- Blaszcyk N. et al., Osteoblast-Derived Factors Induce Androgen-Independent Proliferation and Expression of Prostate-Specific Antigen in Human Prostate Cancer Cells. *Clinical Cancer Research* 10:1860(2004).
- Barrera A. et al., Mapping of the Hepatitis B Virus Pre-S1 Domain Involved in Receptor Recognition, *J. Virology* 79(15):(2005).

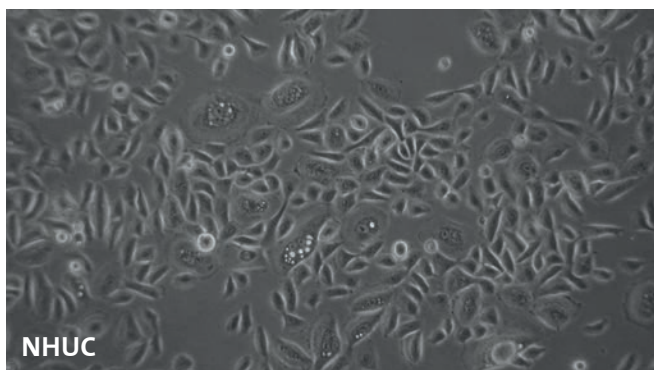
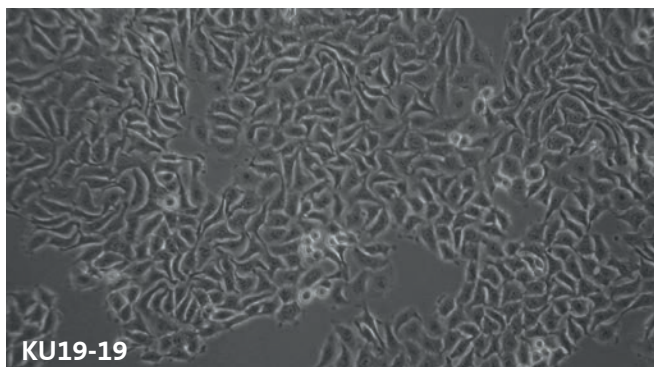

Epithelial bladder cancer cells (KU19-19), and normal human urothelial cells (NHUC) cultured for 4 days on Corning Primaria 6 well plates (353846). Magnification 100 X. Micrographs courtesy of Cancer Research UK laboratories at St James University Hospital, Leeds.

## Falcon® Cell Culture Inserts and Companion Plates

Falcon Cell Culture Inserts permit the diffusion of media components to both apical and basolateral cell surfaces, mimicking the *in vivo* process



Falcon Cell Culture Inserts are available in convenient 6, 12, and 24 well sizes. Packed in individual blisterpacks, Falcon Cell Culture Inserts give you the flexibility to run from 1 to 24 samples at one time.

### Cell culture on microporous membranes

Cell culture systems containing microporous, permeable membranes have been shown to promote differentiation of a variety of epithelial and mesenchymal cells *in vitro*. Because of the bilateral access to nutrients, cytokines, hormones and other media supplements, cells cultured on permeable supports show a higher degree of morphological and functional differentiation when compared to cells cultured on non-permeable plastic surfaces. Falcon Cell Culture Inserts have been successfully used for a variety of applications, including transport, diffusion, secretion, permeability, and drug uptake studies of natural and synthetic compounds; analysis of cellular uptake of pathogens; *in vitro* toxicology studies using a variety of cells; analysis of cellular migration and invasion of normal and malignant cells; co-culture studies and air-liquid interface models. Independent access to the apical and basolateral domains of polarized cells permits the study of protein sorting, receptor localization and microbial pathogenesis.

### Typical applications for Falcon Cell Culture Inserts

- ▶ Endothelial models for studies of cell-cell interaction, adhesion, angiogenesis, matrix formation, cell-ECM interaction, metastasis, inflammation, and invasion
- ▶ Respiratory epithelium culture for pharmacology, toxicology, cystic fibrosis research, and microbial pathogenesis
- ▶ Renal tubule cell culture for *in vitro* toxicology and pharmacology
- ▶ Normal Human Epidermal Keratinocyte *in vitro* toxicology models
- ▶ Epithelial polarity studies on MDCK, LLPCk, and other cell types
- ▶ Hepatocyte culture for drug toxicity and biotransformation studies
- ▶ Culture of intestinal epithelial cells for drug bioavailability studies



Falcon Cell Culture Inserts contain polyethylene terephthalate (PET) membranes, which are available in a wide variety of pore sizes and densities. The insert housing, also made from PET, is not tissue culture (TC)-treated in order to minimize cell growth on insert side walls. For best results, Falcon Cell Culture Inserts should be used together with Falcon Cell Culture Insert Companion Plates. These Companion Plates are TC-treated and feature a unique labyrinth lid design and condensation rings, which reduce evaporation and contamination.

Due to the low protein binding property of PET membranes, Falcon Cell Culture Inserts are especially suited for immunohistochemistry<sup>1</sup>, co-culture to study intercellular communication<sup>2</sup>, transport studies<sup>3</sup>, and drug screening<sup>4,5</sup>. Compatibility with fixatives and the durability of PET membranes makes them ideal for both light and electron microscopy<sup>1</sup>. Membranes will not tear or curl and remain easy to handle when removed from the insert housing.

**Select the best membrane for your application**

- ▶ Larger pore size membranes for investigating chemotaxis, invasion, and migration
- ▶ Transparent membranes for visualization of cells by light microscopy (See Figure A below, 0.4 µm)
- ▶ High pore density membranes for maximal diffusion when studying transport, secretion, or drug uptake (See Figure B below, 0.4 µm HD)



Figure A

Figure B

**Falcon Cell Culture Inserts**

- ▶ Track-etched PET membranes have a smooth surface and defined cylindrical pores that traverse the membrane
- ▶ Low protein binding PET membrane
- ▶ Sterilized by gamma irradiation
- ▶ A wide variety of configurations including 6, 12, and 24 well
- ▶ A broad selection of membrane pore sizes, 0.4, 1.0, 3.0, and 8.0 µm diameter
- ▶ Packed in individual blister packs, 48 inserts/case
- ▶ Non-Tissue Culture-treated insert housings prevent promiscuous growth of cells on the insert walls
- ▶ Innovative hanging design facilitates pipeting and allows for co-culture

**Falcon Cell Culture Insert Companion Plates**

Falcon Cell Culture Insert Companion Plates have been specially designed for use with Falcon or Corning® BioCoat™ Cell Culture Inserts so evaporation and contamination due to improper lid fit is eliminated.

In the Feeding Position, pipet access is improved for fluid handling on the basolateral side. Reagents can be added quickly and consistently for timed experiments. Aspiration of media from the well is easier, reducing the risk of contamination.

In the Incubation Position, Falcon Cell Culture Inserts remain locked in position in their Falcon Companion Plate wells. Media will not wick up between the insert and well wall. The unique Falcon low-evaporation lid provides a tortuous air-passage system that reduces evaporation and contamination.

**References**

1. De Boer., W.I., et al., *J. Histochem. & Cytochem.* 42:77 (1994).
2. Perachiotti, A. and Darbre, P.D., *Exp. Cell Res.* 213:404 (1994).
3. Halleux, C. and Schneider Y.-J., *In Vitro Cell. Dev. Biol.* 27A:293 (1991).
4. Dehouck, M.P., et al., *J. Neurochem.* 58:1790 (1992).
5. Dehouck, M.P., et al., *J. Neurochem.* 54:1798 (1990).

**Falcon Cell Culture Inserts are easy to use with Falcon Companion Plates**

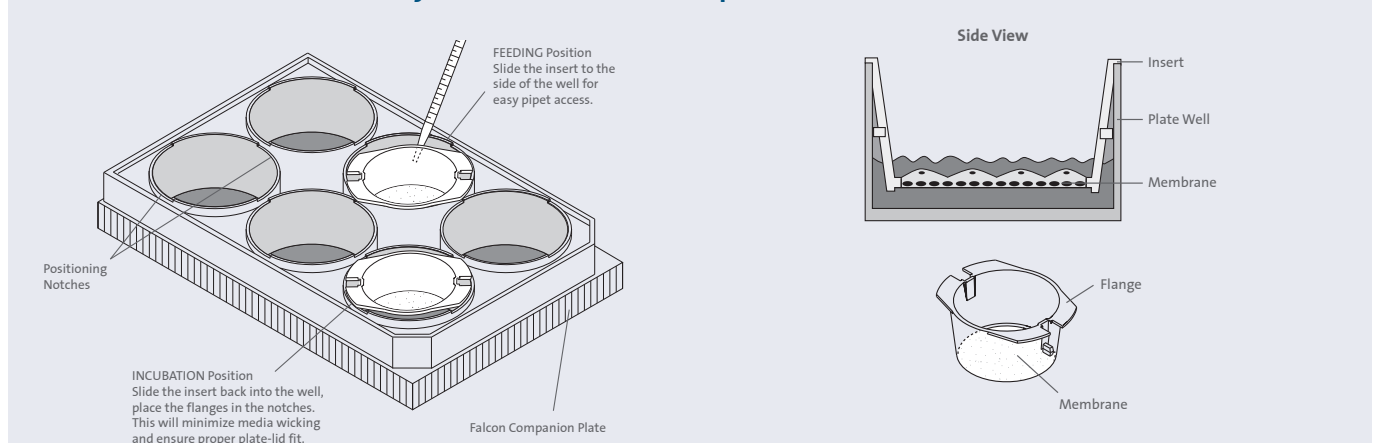

# Falcon® Cell Culture Inserts and Companion Plates (Continued)

## Falcon Cell Culture Inserts Ordering Information

### Transparent PET Membrane

0.4 µm pore size,  $1.6 \times 10^6$  pores/cm<sup>2</sup>

Cat. No.	Description	Qty/Pk	Qty/Cs
353090	Inserts for 6 well plates	1	48
353180	Inserts for 12 well plates	1	48
353095	Inserts for 24 well plates	1	48

#### Applications

- ▶ Scanning and transmission electron microscopy
- ▶ Visualization of live cells by light microscopy
- ▶ Removal of membrane from housing
- ▶ Immunocytochemical staining

### High Density, Translucent PET Membrane

0.4 µm pore size,  $1.0 \times 10^8$  pores/cm<sup>2</sup>

Cat. No.	Description	Qty/Pk	Qty/Cs
353493	Inserts for 6 well plates	1	48
353494	Inserts for 12 well plates	1	48
353495	Inserts for 24 well plates	1	48

#### Applications

- ▶ Transport, diffusion and secretion of small molecules into, out of, or through a cell monolayer
- ▶ Barrier function (Trans epithelial Electrical Resistance (TEER) measurements)
- ▶ Drug bioavailability

### Transparent PET Membrane

1.0 µm pore size,  $1.6 \times 10^6$  pores/cm<sup>2</sup>

Cat. No.	Description	Qty/Pk	Qty/Cs
353102	Inserts for 6 well plates	1	48
353103	Inserts for 12 well plates	1	48
353104	Inserts for 24 well plates	1	48

#### Applications:

- ▶ General-purpose membrane
- ▶ Growth and visualization of live cells
- ▶ Transport, secretion, and diffusion of most molecules into, out of, and through cell monolayers
- ▶ Immunocytochemical staining
- ▶ Drug bioavailability assays
- ▶ In general, this is the maximum pore size available to prevent cell migration through pores

### Transparent PET Membrane

3.0 µm pore size,  $8 \times 10^5$  pores/cm<sup>2</sup>

Cat. No.	Description	Qty/Pk	Qty/Cs
353091	Inserts for 6 well plates	1	48
353181	Inserts for 12 well plates	1	48
353096	Inserts for 24 well plates	1	48

#### Applications:

- ▶ Visualization by light microscopy
- ▶ Transmission and scanning electron microscopy
- ▶ Useful for studying transport of larger molecules (lipoproteins) and viruses
- ▶ Transendothelial migration
- ▶ Smooth muscle migration
- ▶ Endothelial cell migration

*Note: In long-term cultivation, epithelial cells grown in a monolayer may traverse a naked membrane and grow on the top and bottom of the membrane.*

### High Density, Translucent PET Membrane

3.0 µm pore size,  $2 \times 10^6$  pores/cm<sup>2</sup>

Cat. No.	Description	Qty/Pk	Qty/Cs
353092	Inserts for 6 well plates	1	48
353292	Inserts for 12 well plates	1	48
353492	Inserts for 24 well plates	1	48

#### Applications:

- ▶ Transport, secretion and diffusion of large molecules or viruses
- ▶ Cell migration studies
- ▶ This pore size offers maximum diffusion of large molecules or viruses

*Note: In long-term culture, epithelial cells grown in a monolayer may traverse a naked membrane and grow on the top and bottom of the membrane.*

### Transparent PET Membrane

8.0 µm pore size,  $1 \times 10^5$  pores/cm<sup>2</sup>

Cat. No.	Description	Qty/Pk	Qty/Cs
353093	Inserts for 6 well plates	1	48
353182	Inserts for 12 well plates	1	48
353097	Inserts for 24 well plates	1	48

#### Applications:

- ▶ Tumor invasion
- ▶ Cell migration
- ▶ Chemotaxis
- ▶ Metastasis

## Falcon Cell Culture Insert Companion Plates Ordering Information

### Falcon Cell Culture Insert Companion Plates

Specifically designed for use with Falcon or Corning® BioCoat™ Cell Culture Inserts. Tissue Culture-treated, polystyrene, sterile, nonpyrogenic, with lid. May be used with or without cell culture inserts.

Cat. No.	Description	Qty/Pk	Qty/Cs
355467	6 well plate (Deep-Well)	1	4
353502	6 well plate	1	50
353503	12 well plate	1	50
353504	24 well plate	1	50

The following Application Notes are available by searching for the literature code at [www.corning.com/lifesciences](http://www.corning.com/lifesciences).

No.	Author/Title	Lit. Code
401	<b>K. Amsler, et al.</b> <i>Maintenance and Functional Properties of Primary Turtle Bladder Epithelial Cells Cultured on Falcon Cell Culture Inserts</i>	CLS-DL-CC-060
402	<b>E. J. Roemer and Simon S. R. Simon</b> <i>Falcon Cell Culture Inserts as a Supportive Substrate for an In Vitro Extracellular Matrix System</i>	CLS-DL-CC-061
405	<b>H. Gray and O Fedun</b> <i>Preparation of Falcon Cell Culture Inserts for Scanning Electron Microscopy</i>	CLS-DL-CC-062
406	<b>M. Gray and F. Morris</b> <i>Preparation of Falcon Cell Culture Inserts for Transmission Electron Microscopy</i>	CLS-DL-CC-063
407	<b>E.J. Roemer</b> <i>An In Vitro Assay for Study of Neutrophil Migration Through Interstitial Matrix Using Falcon Cell Culture Inserts</i>	CLS-DL-CC-064
408	<b>B. J. Johnson</b> <i>Induction of Lymphoproliferation by Antigen-primed Macrophage Across Falcon Cell Culture Inserts</i>	CLS-DL-CC-065
409	<b>J. Font, et al.</b> <i>Use of Falcon Cell Culture Inserts to Reconstruct a Differentiated Human Epidermis In Vitro: Expression of Cell Adhesion Molecules (Integrins)</i>	CLS-DL-CC-066
412	<b>W.I. deBoer, et al.</b> <i>A Physiological and Morphological In Vitro Model for Normal Human Urothelium Cultured on Falcon Cell Culture Inserts</i>	CLS-DL-CC-067
413	<b>X. Quan and H.P. Godfrey</b> <i>In Vitro Study of Cytokine Mediated Activation of Endothelial Cell Permeability Using Falcon Cell Culture Inserts</i>	CLS-DL-CC-068
459	<b>Mark W. Musch</b> <i>Preparation of Falcon Cell Culture Inserts for Confocal Indirect Immunofluorescence: Fixation and Staining of Caco-2/bbe (C2) Cells with Various Dyes</i>	CLS-DL-CC-079
463	<b>Y. Yamasaki</b> <i>Use of Falcon Cell Culture Inserts to Evaluate Allelopathic Effects Among Marine Phytoplankters In Vitro</i>	CLS-DL-CC-081

For additional references or for help with an application, please contact Corning Life Sciences Technical Support.

## Physical Specifications for Falcon Cell Culture Inserts

	6 well	12 well	24 well
Effective Diameter of Membrane (mm)	23.1	10.5	6.4
Effective Growth Area of Membrane (cm <sup>2</sup> )	4.2	0.9	0.3
Insert Height (mm)	17.2	17.2	17.5
Distance from Membrane to the Bottom of the Well (mm)	0.9	0.9	0.8
Suggested Media in Insert (mL)	1.5-2.5	0.4-1.0	0.2-0.35
Suggested Media in Well (mL)	2.7-3.2	1.4-2.3	0.7-0.9
Growth Area in Plate Well (cm <sup>2</sup> )	9.6	3.8	2.0

### Tips

- ▶ Falcon Cell Culture Inserts are also available in an automation friendly, one-piece Multiwell Insert plate format. Available in 1.0, 3.0, and 8.0 μm pore sizes for manual and robotic screening of cells. Please see pages 28 and 30 for more detailed information.
- ▶ Falcon Cell Culture Inserts are also available with consistently pre-applied extracellular matrix (ECM) proteins and ECM components for improved cell attachment, growth or differentiation. For more information, visit [www.corning.com/lifesciences](http://www.corning.com/lifesciences)
- ▶ For applications based on fluorescent techniques see Corning® FluoroBlok™ Inserts (pages 32 and following).
- ▶ You may have to increase your seeding density (number of cells/cm<sup>2</sup>) when changing from non-permeable polystyrene to permeable cell culture surfaces. Start with seeding cell densities 25-50% higher. The time for initial attachment may also increase.
- ▶ To avoid air bubbles forming under the inserts, use pre-warmed media and follow the directions found in each case for placing inserts into plate wells.
- ▶ To improve cell attachment to uncoated inserts, incubate inserts for 20-30 minutes with media (containing serum if it will be used) before adding cells.

### Related Products

- ▶ Falcon 24 Multiwell Insert Systems . . . . . 28
- ▶ Falcon 96 Multiwell Insert Systems . . . . . 30

# Falcon® 24 Multiwell Insert Systems

- ▶ Automate and increase productivity and throughput of cell culture insert-based assays
- ▶ Designed for bioavailability, transport, permeability, cell migration, and tumor invasion studies

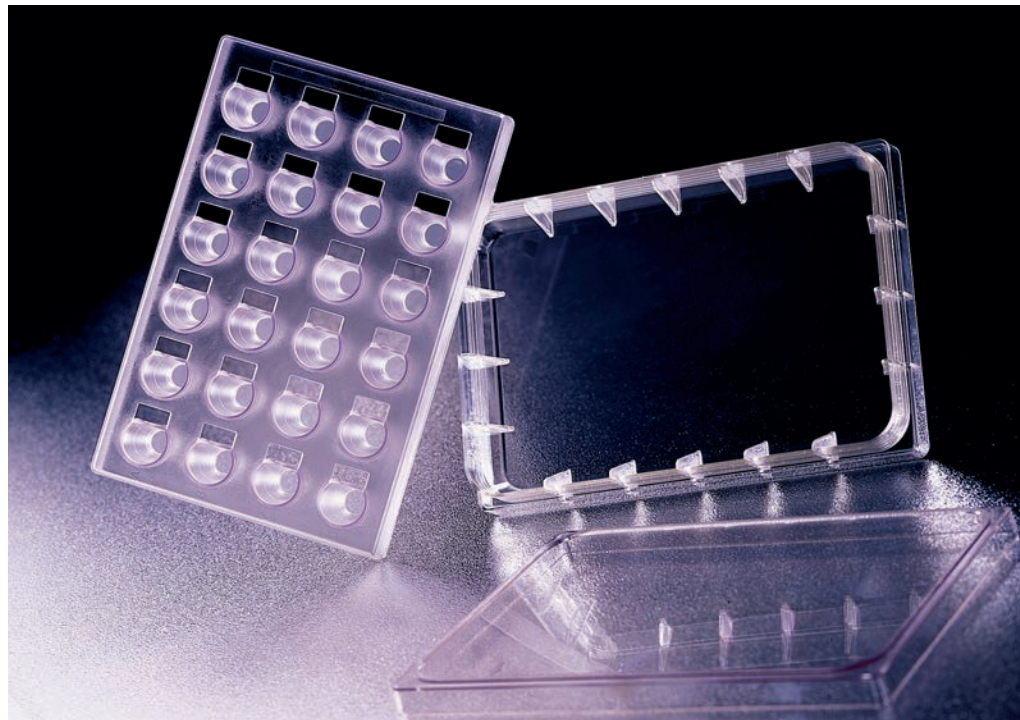

## Falcon 24 Multiwell Insert Systems

Free your lab from tedious manipulation of individual cell culture inserts with Falcon 24 Multiwell Insert Systems. Each system contains an automation-friendly 24 well cell culture membrane insert suitable for both manual and robotic screening of cells in bioavailability, toxicity, cell migration, and tumor invasion assays.

Falcon 24 Multiwell Insert Systems are designed to automate many commonly used cell-based assays for drug discovery. Available in a choice of membrane pore sizes, 24 Multiwell inserts have been successfully used for a variety of applications including permeability studies for oral bioavailability (e.g., Caco-2 cells), chemotaxis, cell migration and invasion assays. These insert systems offer all the benefits of Falcon Individual Cell Culture Inserts in an automation-friendly format that is compatible with most robots and fluid handlers. The Falcon 24 Multiwell Insert Plate is a single unit that is compatible with all Falcon 24 well plates and Feeder Tray.

## Typical applications for Falcon 24 Multiwell Insert Systems

- ▶ Culture of intestinal epithelial cells (e.g., Caco-2 cells) for drug bioavailability and transport studies
- ▶ Barrier function [TEER] measurements of epithelial cells (i.e., MDCK cells)
- ▶ Epithelial polarity studies of protein sorting, receptor location, and vectorial transport
- ▶ Hepatocyte cultures for drug toxicity and biotransformation
- ▶ Angiogenesis studies
- ▶ Tumor cell invasion and migration

## Physical Specifications

### Falcon 24 Multiwell Insert Systems and Cell Culture Insert Companion Plates

Effective Diameter of Membrane (mm)	6.5
Effective Growth Area of Membrane (cm <sup>2</sup> )	0.3
Distance of Membrane to Bottom of Well (mm)	2.0
Insert Height (mm)	18
Suggested Media Volume in Insert (μL)	300-500
Suggested Media Volume in Well (μL)	1000-1400
Effective Growth Area in 24 well Plate (cm <sup>2</sup> per well)	2.0
Pore Density: 1.0 μm inserts (pores/cm <sup>2</sup> )	1.6 x 10 <sup>6</sup>
Pore Density: 3.0 μm inserts (pores/cm <sup>2</sup> )	8.0 x 10 <sup>5</sup>
Pore Density: 8.0 μm inserts (pores/cm <sup>2</sup> )	1.0 x 10 <sup>5</sup>

## Falcon 24 Multiwell Insert Systems Ordering Information

### Falcon® 24 Multiwell Insert Systems

with Feeder Tray and Lid

Cat. No.	Description	Qty/Pk
351180	1 µm pore size	1
351181	1 µm pore size	5

### Falcon 24 Multiwell Insert Systems

with 24 well Plate and Lid

351182	3 µm pore size	1
351183	3 µm pore size	5
351184	8 µm pore size	1
351185	8 µm pore size	5

### Falcon 24 Well Feeder Tray

Specifically designed for use with Falcon 24 Multiwell Insert Systems

351186	Feeder Tray with Lid	5
--------	----------------------	---

### Falcon 24 Well Plates

For use with Falcon 24 Multiwell Insert Systems

Cat. No.	Description	Qty/Pk	Qty/Cs
353047	Standard Tissue Culture	1	50
353226	Standard Tissue Culture	6	36
353935	Standard Tissue Culture	10	60
353847	Corning® Primaria™ Tissue Culture	1	50
351147	Not Treated	1	50

The following Application Note is available by searching for the literature code at [www.corning.com/lifesciences](http://www.corning.com/lifesciences).

No.	Author/Title	Lit. Code
419	D. Henderson and D. Asa <i>Design and Evaluation of an Automation-Compatible Multiwell Insert for Cell-Based Assays</i>	CLS-DL-CC-072

For additional references or for help with an application, please contact Corning Life Sciences Technical Support.

## Related Products

- ▶ Falcon Cell Culture Inserts. . . . . 24



## Falcon® 96 Multiwell Insert Systems

Automate and miniaturize your xenobiotic permeability and transport studies

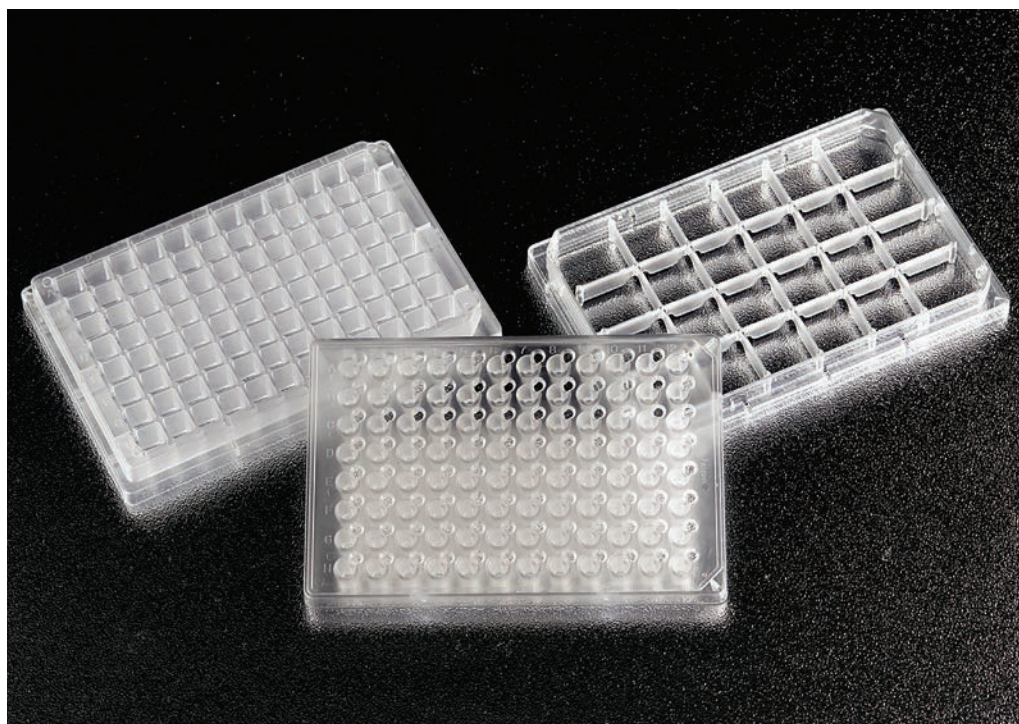

The Falcon 96 Multiwell Insert System is a cell culture insert platform suitable for both manual and robotic screening of compounds in cell-based assays. The system has been tested for its ability to produce a differentiated monolayer of Caco-2, LLC-PK<sub>1</sub>, and MDCK cells making it an ideal platform for *in vitro* bioavailability and permeability studies.

This automation compatible platform is composed of a 1.0 µm pore size PET membrane-based 96 Multiwell Insert plate, a media feeder tray, and a lid. The drop-in baffle for the Feeder Tray mitigates media sloshing and lowers the risk of contamination. To analyze individual samples, simply transfer the insert plate into the Falcon 96 Square Well, Angled-Bottom Plate. If desired, the Falcon 96 Square Well, Angled-Bottom Plate may be used in conjunction with the insert for culturing the cells, eliminating the transfer step from the single-well feeder tray for sample analysis.

- ▶ Automation compatible design
- ▶ Format compatible with most robots and fluid handling instruments
- ▶ Complete sample recovery
- ▶ The Falcon 96 Square Well, Angled-Bottom Plate features an angled bottom for more complete sample utilization
- ▶ Excellent reproducibility
- ▶ One-piece feeder tray enhances consistency in well-to-well monolayer growth
- ▶ Total assay flexibility—ideal for transport studies
- ▶ System can be used with many cell lines including Caco-2, MDCK, and LLC-PK<sub>1</sub>, for basal to apical or apical to basal measurements of drug transport



### Intra-Plate Reproducibility of the Falcon® 96 Multiwell Insert System

Format used to Culture Monolayers	TEER (ohms cm <sup>2</sup> )	Mannitol P <sub>app</sub> (x 10 <sup>-6</sup> cm/sec)	Ritonavir P <sub>ap</sub> (x 10 <sup>-6</sup> cm/sec)
Falcon 96 Square Well, Angled-Bottom Plate	272 (CV=26%)	0.72 (CV=22%)	9.0 (CV=13%)
Falcon Feeder Tray for 96 Multiwell Insert	420 (CV=16%)	0.70 (CV=13%)	11.0 (CV=2.5%)

Permeability measured in Caco-2 cell monolayers cultured for 21-days in the Falcon Feeder Tray or Falcon 96 Square Well, Angled-Bottom Plate. While the Feeder Tray with drop-in baffle facilitates medium renewal, comparable results can be obtained in either format. Culturing cells in the Falcon Feeder Tray enhances consistency in well-to-well monolayer growth (TEER values) and function (P<sub>app</sub> values).

### Physical Specifications

#### Falcon 96 Multiwell Insert Systems

Effective Diameter of Membrane (mm)	3.2
Effective Growth Area of Membrane (cm <sup>2</sup> )	0.0804
Insert Height (mm)	10.4
Distance from Membrane to the Bottom of Well (mm) (low side inner)	2.87
(high side inner)	4.27
Suggested Media Volume in Insert (mL)	0.5-0.75
Suggested Media Volume in Well (mL) (square well, angled bottom plate)	0.26
Growth Area in Companion TC Plate Well (cm <sup>2</sup> )	0.64

### Falcon 96 Multiwell Insert Systems Ordering Information

Cat. No.	Description	Qty/Pk
<b>Falcon 96 Multiwell Insert Systems</b>		
351130	One insert plate with feeder tray and lid	1
351131	Five insert plates with feeder trays and lids	5
353938	Five insert plates with 96 square well, angled-bottom plates and lids	5
<b>Falcon 96 Square Well, Angled-Bottom Plate and Lid</b>		
353925	Non-TC-treated polystyrene, nonpyrogenic	5
<b>Falcon 96 Well Feeder Tray and Lid</b>		
353924	Non-TC-treated polystyrene, nonpyrogenic	5

# Corning® FluoroBlok™ Cell Culture Inserts

Increase cell migration and invasion assay productivity with real-time fluorescence



## Corning FluoroBlok Cell Culture Inserts

Available as convenient 24 well individual inserts in two different pore sizes. Packed in individual blister packs, Corning FluoroBlok Cell Culture Inserts give you the flexibility to run from 1 to 24 samples at one time.

## Detect cell migration and invasion in a homogeneous fluorescent assay system

Corning FluoroBlok Cell Culture Inserts are designed with a unique light-tight PET membrane that efficiently blocks the transmission of light within the range of 400-700 nm. Fluorescently labeled cells present in the top chamber of the insert are made invisible by the Corning FluoroBlok membrane. Once labeled cells migrate through the membrane, they are no longer shielded from the light source and are easily detected with a fluorescence plate reader.

- Simplify insert-based assays—Unique, light-tight PET membrane makes it easy to specifically detect fluorescently labeled cells and molecules below the insert.
- Increase insert assay productivity—Save time and labor in chemotaxis, cell migration, and invasion assays by automating your assay detection with real-time fluorescence.
- Eliminate cell culture insert manipulation—Get rapid data collection using a fluorescence microplate reader or microscope without the need for plate washing or tedious, manual cell scraping and counting. Chart migration of cells and molecules in real time without dismantling or destroying the insert.

## Applications

Corning FluoroBlok effectively blocks >99.0% of the light transmission from 400-700 nm, allowing you the flexibility to choose from a variety of fluorophores for bioavailability, toxicity, chemotaxis, cell migration, and tumor invasion assays. As long as the fluorophores of choice are within the blocking range of the Corning FluoroBlok membrane, multiplex detection is also possible.

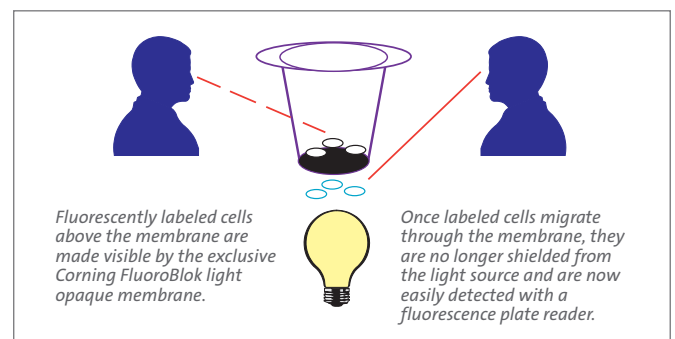

*Fluorescent cells and molecules are easily detected as they migrate through Corning FluoroBlok Inserts.*

## Physical Specifications

### Corning® FluoroBlok™ Cell Culture Inserts

Effective Diameter of Membrane (mm)	6.4
Effective Growth Area of Membrane (cm <sup>2</sup> )	0.3
Insert Height (mm)	17.5
Distance from Membrane to the Bottom of Well (mm)	0.8
Suggested Media Volume in Insert (mL)	0.2-0.35
Suggested Media Volume in Well (mL)	0.7-0.9
Growth Area in Companion TC Plate Well (cm <sup>2</sup> )	2.0
Pore Density: 3.0 µm Inserts (pores/cm <sup>2</sup> )	8±2 x 10 <sup>5</sup>
Pore Density: 8.0 µm Inserts (pores/cm <sup>2</sup> )	6±2 x 10 <sup>4</sup>

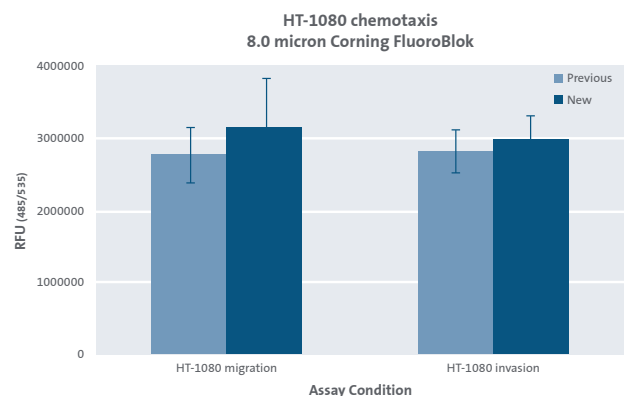

Migration (uncoated inserts) and invasion (Corning Matrigel®-coated inserts) of HT-1080 cells. The invasion index (invasive HT-1080 cells: non-invasive 3T3 cells) was 10.9 for the previous membrane and 10.1 for the new membrane. Z' factors (a statistical characteristic of assay suitability) were previous, 0.616; new, 0.558 (previous, n=6, new, n=24).

### Tips

- Corning FluoroBlok Cell Culture Inserts are also available in an automation-friendly Multiwell Insert plate format. Available in 3.0 and 8.0 µm pore sizes for manual and robotic screening of cells. Please see pages 34 and 36 for more detailed information.
- Cell labeling efficiencies will vary depending on fluorophore and cell type. For optimized conditions, titration of fluorophore is recommended.
- Visit [www.corning.com/lifesciences](http://www.corning.com/lifesciences) for information on compatible and incompatible fluorophores, frequently asked questions, and application notes.

## Corning® FluoroBlok™ Cell Culture Inserts Ordering Information

Cat. No.	Description	Qty/Pk	Qty/Cs
<b>Corning FluoroBlok Cell Culture Inserts</b>			
351151	3.0 µm inserts for 24 well plates	1	48
351152	8.0 µm inserts for 24 well plates	1	48
<b>Falcon® Cell Culture Insert Companion Plates</b>			
Specifically designed for use with Falcon or Corning BioCoat™ Cell Culture Inserts. Tissue culture-treated polystyrene, sterile, nonpyrogenic, with lid. May be used with or without cell culture inserts.			
353504	24 well plate	1	50

The following Application Note is available by searching for the literature code at [www.corning.com/lifesciences](http://www.corning.com/lifesciences).

No.	Author/Title	Lit. Code
451	Corning Life Sciences <i>Compatible Fluorophores and Dyes for Corning FluoroBlok Inserts and Insert Systems</i>	CLS-DL-CC-077

For additional references or for help with an application, please contact Corning Life Sciences Technical Support.

### Related Products

- Corning FluoroBlok 24 Multiwell Insert System . . . . . 34
- Corning FluoroBlok 96 Multiwell Insert System . . . . . 36

# Corning® FluoroBlok™ 24 Multiwell Insert Systems

Increase cell migration and invasion assay productivity with simplified fluorescence detection and real-time analysis



## Corning FluoroBlok 24 Multiwell Insert System

Each system contains an automation-friendly 24 Multiwell cell culture membrane insert suitable for both manual and robotic screening of cells or compounds. Handle 24 inserts simultaneously; all 24 inserts are part of a single unit that is compatible with Falcon 24® Well Plates and Feeder Tray.

## Corning FluoroBlok 24 Multiwell Insert Systems

The Corning FluoroBlok Insert System is made with a unique light-tight PET membrane that effectively blocks the transmission of light from 400-700 nm. Fluorescence from labeled cells or compounds present in the top chamber of the insert system is blocked from detection in the bottom chamber by the intervening dyed membrane. Once fluorescently labeled cells or compounds pass through the membrane, they are no longer shielded from the light source and are easily detected with a bottom-reading fluorescence plate reader. The wide blocking range of the Corning FluoroBlok membrane allows the flexibility to choose a variety of fluorophores for chemotaxis, cell migration, tumor cell or bacterial invasion, leukocyte extravasation, cell signaling, toxicity and permeability studies for oral bioavailability and absorption assays (e.g., Caco-2 cells).

- ▶ Save time and labor using automated fluorescence detection
- ▶ Eliminate cell insert manipulation—get rapid data collection without the need for plate washing or manual cell scraping and counting. Chart migration of cells and molecules in real-time without dismantling or destroying the insert
- ▶ Increase sample throughput—automate many commonly used membrane-based cell assays and increase the efficiency, productivity and throughput of these assays in the drug discovery process
- ▶ Handle 24 inserts simultaneously—all 24 wells are part of a single unit that is compatible with Falcon 24 well Plates and Feeder Tray
- ▶ Each insert has a generous, automation-compatible sampling port. When used with Falcon 24 well plates, users can sample above and below the membrane with standard 200 µL or 1000 µL pipet tips or automated fluid handler tips.

## References

1. Crouch, M.F., et. al., *J. Cell. Biol.* 152:263 (2001).
2. Crouch, M.F., *J. Neuro. Meth.* 104:87 (2000).
3. Townson, J.R., et. al., *J. Biol. Chem.* 275:39254 (2000).
4. Yamakawa, S., et. al., *Biol. Pharm. Bull.* 10:1264 (2000).
5. Tang, S., et. al., *J. Cell Biol.* 147:1073 (1999).



## Physical Specifications

### Corning® FluoroBlok™ 24 Multiwell Insert Systems

Effective Diameter of Membrane (mm)	6.5
Effective Growth Area of Membrane (cm <sup>2</sup> )	0.3
Distance from Membrane to Bottom of Well (mm)	2.0
Insert Height (mm)	18
Suggested Media Volume in Insert (μL)	300-500
Suggested Media Volume in Well (μL)	1000-1400
Effective Growth Area in 24 well Plate (cm <sup>2</sup> )	2.0
Pore Density: 3.0 μm Inserts (pores/cm <sup>2</sup> )	8±2 x 10 <sup>5</sup>
Pore Density: 8.0 μm Inserts (pores/cm <sup>2</sup> )	6±2 x 10 <sup>4</sup>

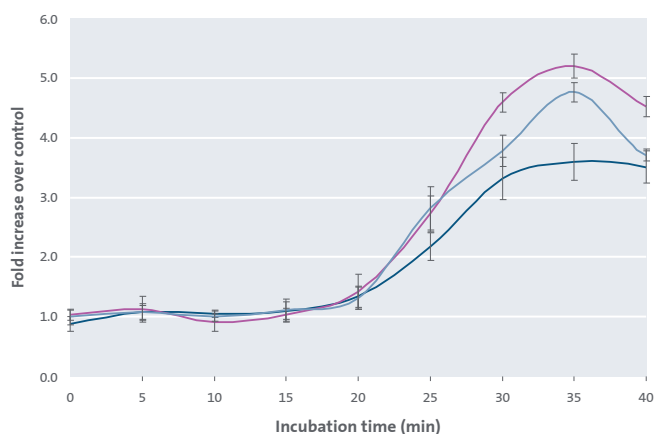

**Run kinetic assays easily.** Calcein AM labeled THP-1 cells (a monocytic cell line) were seeded at 100,000 cells/well on fibronectin coated inserts and chemotaxis to 25 nM MCP-1 (R&D Systems®) was measured using a PerkinElmer EnVision® plate reader. Peak response time in three separate assays (n=3) was 30-35 min.

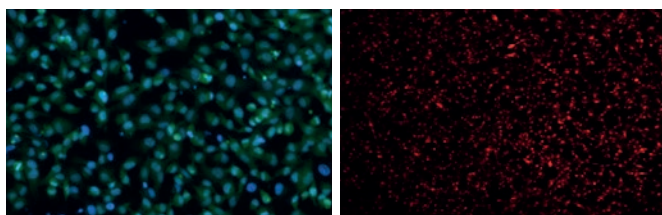

**Fluorescence multiplexing.** Migrated HT-1080 cells post-labeled with Hoechst 33342 (blue) and Calcein AM (green) [left] or pre-labeled with DiIC<sub>12</sub>(3) (red) [right].

### Tips

- Cell labeling efficiencies will vary depending on fluorophore and cell type. For optimized conditions, titration of fluorophore is recommended.
- Visit [www.corning.com/lifesciences](http://www.corning.com/lifesciences) for information on compatible and incompatible fluorophores, frequently asked questions, and application notes

## Corning FluoroBlok 24 Multiwell Insert Systems Ordering Information

Cat. No.	Description	Qty/Pk
<b>Corning FluoroBlok 24 Multiwell Insert Systems</b> with 24 well Plate and Lid		
351155	3.0 μm pore size	1 plate
351156	3.0 μm pore size	5 plates
351157	8.0 μm pore size	1 plate
351158	8.0 μm pore size	5 plates

### Falcon® 24 well Feeder Tray

Specifically designed for use with Corning FluoroBlok 24 Multiwell Insert Systems

351186	Feeder Tray with Lid	5 plates
--------	----------------------	----------

Cat. No.	Description	Qty/Pk	Qty/Cs
----------	-------------	--------	--------

### Falcon 24 well Plates

For use with Corning FluoroBlok 24 Multiwell Insert Systems

353047	Standard tissue culture	1/tray	50
353226	Standard tissue culture	6/bag	36
353935	Standard tissue culture	10/RS Tray*	60
353847	Corning Primaria™	1/tray	50
351147	Non-treated surface	1/tray	50

\* Ready-Stack Tray

The following Application Notes are available by searching for the literature code at [www.corning.com/lifesciences](http://www.corning.com/lifesciences).

No.	Author/Title	Lit. Code
436	Corning Life Sciences <i>Set up Guidelines and Dimensional Templates for Fluorescence Plate Readers used with Corning FluoroBlok Insert Systems and Corning BioCoat Multiwell Insert Cell-Based Assays</i>	CLS-DL-CC-074
441	P. Flaherty <i>Screening of Anti-Metastatic Compounds Using ZsGreen1 Reef Coral FluorescentProtein (RCFP) Labeled HT-1080 Tumor Cells</i>	CLS-DL-CC-075
442	P. Flaherty <i>Screening of Anti-Metastatic Compounds by a Fluorescence-Based Tumor Cell Invasion Assay</i>	CLS-DL-CC-076
451	Corning Life Sciences <i>Compatible Fluorophores and Dyes for Corning FluoroBlok Inserts and Insert Systems</i>	CLS-DL-CC-077
484	J. Partridge <i>Migration of Human Mesenchymal Stem Cells using Corning FluoroBlok Cell Culture Inserts</i>	CLS-DL-CC-054
497	Jeff Partridge, Stephen Rimsa, and Paula Flaherty <i>New PET Membrane for Corning FluoroBlok 3.0 μm and 8.0 μm Pore Size Cell Culture Inserts</i>	CLS-DL-CC-042

For additional references or for help with an application, please contact Corning Life Sciences Technical Support.

## Related Products

- Corning FluoroBlok Individual Cell Culture Inserts . . . . . 32

# Corning® FluoroBlok™ 96 Multiwell Insert Systems

- ▶ A solution for automated, high throughput cell-based studies of chemotaxis, migration and invasion
- ▶ Increase cell migration and invasion assay productivity with simplified fluorescence detection and real-time analysis
- ▶ Simplification of chemotaxis, cell migration, and invasion assays
- ▶ Standard technology platform allows multiple protocols
- ▶ Homogeneous protocols for real-time kinetic readouts
- ▶ Real-time detection without dismantling or destroying the insert
- ▶ Increased sample throughput
- ▶ Eliminates need for manual cell scraping and counting
- ▶ Automation friendly
- ▶ 96 Multiwell format is compatible with commercial detectors and fluid handling instruments
- ▶ Unique fluorescence blocking membrane
- ▶ Blocks greater than 99% of the excitation and emission wavelengths of fluorophores commonly used to label cells

The Corning FluoroBlok 96 Multiwell Insert System is a cell culture assay platform designed with automation in mind. The one-piece insert housing and fluorescence blocking micro-porous membrane (available in 3.0 and 8.0  $\mu\text{m}$  pore sizes) enables increased efficiency, productivity and throughput in the drug discovery process. The novel receiver plate design minimizes crosstalk between the wells; the black housing of the 96 Multiwell Insert virtually eliminates autofluorescence. These features ensure fluorescence measurements that result from your assay, not crosstalk or background signal.

## References

1. Dong, J., et al., *EMBO* 23(14):2800 (2004).
2. Nick, J., et al., *Blood* 104(13):3878 (2004).
3. Shen, X., et al., *Exp. Cell Res*, 294(2):420 (2004).
4. Meissner, M., et al., *Circ. Res.*, 94(3):324 (2004).
5. Bockhorn, M., et al., *Cancer Res.* 64(7):2469 (2004).
6. Kuijpers, T.W., et al., *Blood* 103(10):3915 (2004).
7. Violeta, C., et al., *Mol Bio Cell* 16(6):2947 (2005).
8. Sheng-Bin P., et al., *Mol Cancer Research* 3:227 (2005).

## Tips

- ▶ Cell labeling efficiencies will vary depending on fluorophore and cell type. For optimized conditions, titration of fluorophore is recommended.
- ▶ Visit [www.corning.com/lifesciences](http://www.corning.com/lifesciences) for information on compatible and incompatible fluorophores, frequently asked questions, and application notes

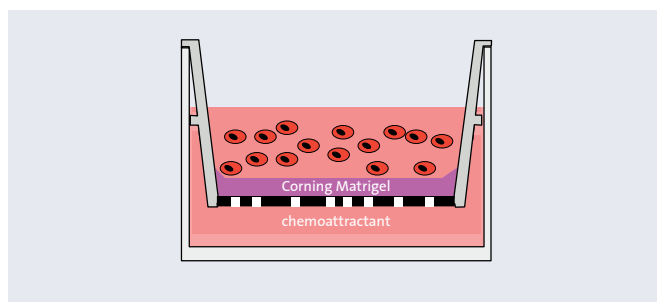
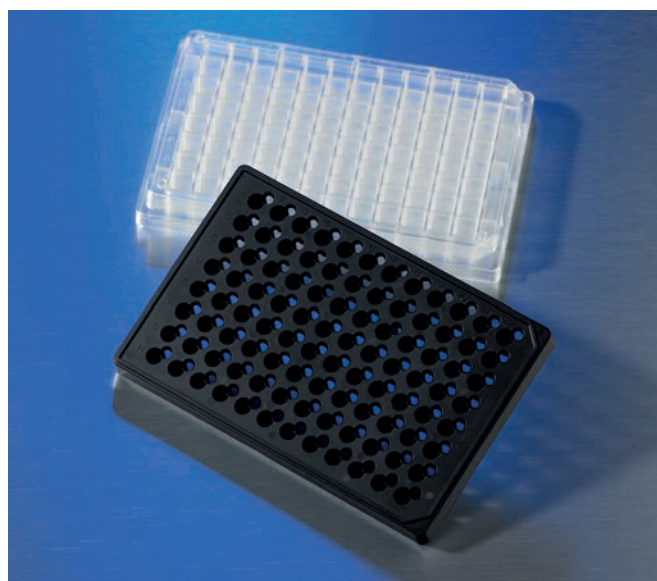

## Cell Migration/Invasion assays using a Corning FluoroBlok Membrane

The PET membrane is dyed to block the excitation and emission wavelengths of fluorophores commonly used to label cells, such as Calcein AM and Dil. Greater than 99% of input fluorescence in the insert is blocked by the dyed membrane. Fluorescently labeled cells stimulated by a chemoattractant, pass through the membrane. The non-migrated population does not have to be removed from the inserts prior to analysis and no further manipulation is required to quantitate the results using a bottom-reading fluorescence plate reader.

## Related Products

- ▶ Corning FluoroBlok Individual Cell Culture Inserts . . . . . 32
- ▶ Corning FluoroBlok 24 Multiwell Insert System . . . . . 34



## Simplify and automate cell-based assays using the Corning® FluoroBlok™ 96 Multiwell Insert System

The Corning FluoroBlok 96 Multiwell Insert System, designed with automation in mind, is well suited for high-throughput analysis of cell-based assays. Good detection sensitivity is observed even when a small number of cells is added to the wells. Variability is also low, as CV values of 10% and below are routinely observed.

The wide blocking range (400-700 nm) of the Corning FluoroBlok membrane allows the flexibility to choose from a variety of fluorophores for screening compounds in cell-based assays such as chemotaxis, cell invasion and migration, and monolayer permeability. Unlike traditional *in vitro* cell-based assays, the Corning FluoroBlok 96 Multiwell Insert System allows rapid data collection without the need for plate washing or tedious manual cell scraping and counting. Each insert has a generous automation-compatible sampling port so you may sample above and below the membrane with standard pipet tips or automated fluid handling equipment. The 96 Multiwell Insert plate format is compatible with many standard fluorescence plate readers, robots and fluid handlers.

## Corning FluoroBlok 96 Multiwell Insert Systems Ordering Information

Cat. No.	Description	Qty/Pk
<b>Corning FluoroBlok 96 Multiwell Insert Systems</b>		
351161	3.0 µm pore size	1 plate
351162	3.0 µm pore size	5 plates
351163	8.0 µm pore size	1 plate
351164	8.0 µm pore size	5 plates
<b>Falcon 96 Square Well, Flat-Bottom Microplate and Lid</b>		
353928	96 square well, flat-bottom microplate	5 plates

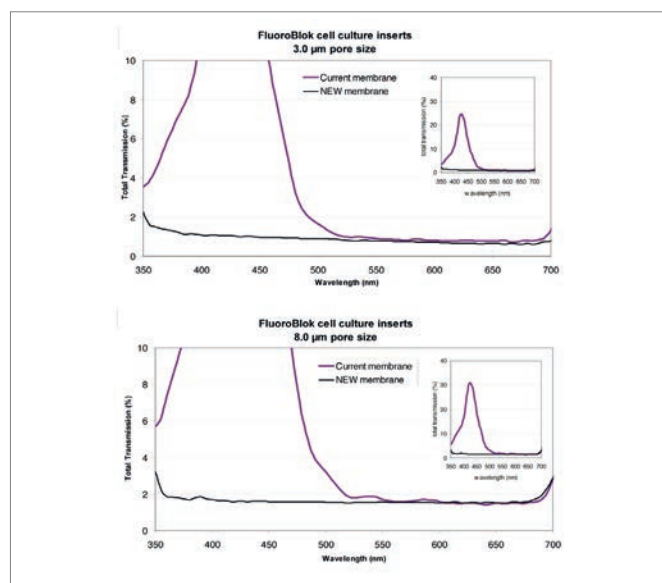

Total Transmission Spectra for 3.0 µm (top) and 8.0 µm (bottom) pore size Corning FluoroBlok inserts as measured by transmission spectrophotometry using HunterLab UltraScan® PRO. Insert detail expanded y axis results.

## Physical Specifications

### Corning FluoroBlok 96 Multiwell Insert Systems

Effective Diameter of Membrane (mm)	3.2
Effective Growth Area of Membrane (cm <sup>2</sup> )	0.0804
Distance from Membrane to Bottom of Well (mm)	1.4
Insert Height (mm)	10.4
Suggested Media Volume in Insert in µL (optimum volume: 50 µL)	30-70
Suggested Media Volume in Well in µL (optimum volume: 225 µL)	200-225
Effective Growth Area in 96-Square Well Flat Bottom Plate (cm <sup>2</sup> per well)	0.64
Pore Density: 3.0 µm Inserts (pores/cm <sup>2</sup> )	8±2 x 10 <sup>5</sup>
Pore Density: 8.0 µm Inserts (pores/cm <sup>2</sup> )	6±2 x 10 <sup>4</sup>

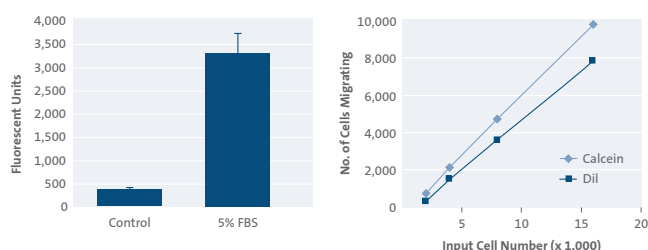

**HUVEC Migration through Corning FluoroBlok 96 Multiwell Inserts (3.0 µm pore size).** HUVEC cells were plated at a density of 2.5x10<sup>4</sup> cells per well on the top of the insert suspended in assay medium. Into the bottom wells, assay medium (control) or chemoattractant (5% FBS in assay medium) were added and the plates were incubated at 37°C for 20 hours in a cell culture incubator. Cells were labeled with fluorescent dyes and cells that migrated to the bottom of the membrane were quantitated using a fluorescence plate reader.

**HT-1080 Migration through Corning FluoroBlok 96 Multiwell Inserts (8.0 µm pore size).** Relationship of migrated cells versus input cell number. The four-hour fluorescence data was converted to cells migrated using the standard curve. The relationship was linear at all cell concentrations. This data indicates that the number of pores in the small membrane area was not saturated, even at higher cell numbers.

The following Application Notes are available by searching for the literature code at [www.corning.com/lifesciences](http://www.corning.com/lifesciences).

No.	Author/Title	Lit. Code
450	A. Goldberger and M. Septak <i>Corning FluoroBlok 96 Multiwell Insert System Enhances High-Throughput Analysis of Cell-Based Assays</i>	CLS-DL-CC-035
436	Corning Life Sciences <i>Set up Guidelines and Dimensional Templates for Fluorescence Plate Readers used with Corning FluoroBlok Insert Systems and Corning BioCoat Multiwell Insert Cell-Based Assays</i>	CLS-DL-CC-074
451	Corning Life Sciences <i>Compatible Fluorophores and Dyes for Corning FluoroBlok Inserts and Insert Systems</i>	CLS-DL-CC-077
457	S. Sanyal <i>Optimized Chemotaxis Conditions for Primary Blood Monocytes or THP-1 Cells using Corning FluoroBlok 96 Multiwell Insert Plates</i>	CLS-DL-CC-078

For additional references or for help with an application, please contact Corning Life Sciences Technical Support.

# Falcon® Microplates Key Dimensions

Falcon® Cultureware

96 Well Microplates		A	B	C	D	D <sup>1</sup>
TC-treated Cat. No.	Non-TC-treated Cat. No.	Plate bottom length	Plate bottom width	Plate height	Well top diameter	Well bottom diameter
353072, 353916, 353936	—	127.63	85.11	14.30	6.85	6.35
353075	351172	127.48	85.52	14.30	6.85	6.35
353296	—	127.49	85.45	14.25	6.73	5.68
353376	—	127.76	85.48	14.40	6.96	6.58
353077, 353227	351177, 353910	127.76	85.59	14.30	6.85	6.35
353219, 353377	—	127.26	85.48	14.40	6.96	6.58
—	351190	127.48	85.56	14.35	6.75	6.45
—	353263	127.48	85.56	14.61	6.96	—

CONTINUED >

384 Well Microplates		A	B	C	D	D <sup>1</sup>
Cat. No.		Plate bottom length	Plate bottom width	Plate height	Well top diameter	Well bottom diameter
353378, 353961, 353988	—	127.76	85.48	14.40	3.70	3.30
353962, 353963	—	127.76	85.48	14.40	3.70	3.30

CONTINUED >

384 Well Microplates, Small Volume		A	B	C	D	D <sup>1</sup>
Cat. No.		Plate bottom length	Plate bottom width	Plate height	Well top diameter	Well bottom diameter
353379, 353380	—	127.76	85.48	7.5	3.30	1.84

CONTINUED >

1536 Well Microplates, High Base		A	B	C	D	D <sup>1</sup>
<i>Ideal for top-reading instruments</i>		Plate bottom length	Plate bottom width	Plate height	Well top diameter	Well bottom diameter
353381, 353382	—	127.76	85.48	10.40	1.70	1.53
353383, 353384	—	127.76	85.48	10.40	1.70	1.53

CONTINUED >

1536 Well Microplates, Low Base		A	B	C	D	D <sup>1</sup>
<i>Ideal for bottom-reading instruments</i>		Plate bottom length	Plate bottom width	Plate height	Well top diameter	Well bottom diameter
353385, 353386	—	127.76	85.48	10.40	1.70	1.53

CONTINUED >

96 Well Microplate

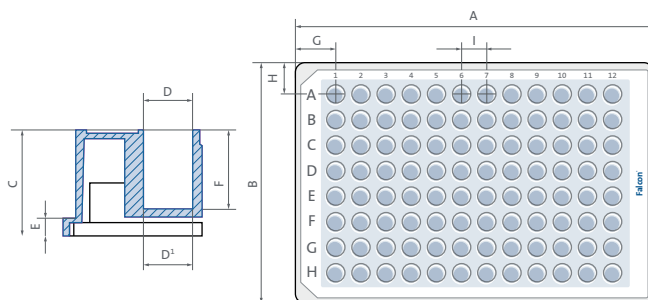

For lid dimensions, please contact Corning Life Sciences Technical Support or visit [www.corning.com/lifesciences](http://www.corning.com/lifesciences).

Dimensions in mm unless otherwise specified.

E	F	G	H	I						
Flange	Well depth	Left edge to A1 center	Top edge to A1 center	Well center to center	Bottom thickness (µm)	Well bottom shape	Total volume (µL)	Working volume (µL)	Growth Area (mm <sup>2</sup> )	Upper well shape
6.10	10.76	14.37	11.34	8.99	—	Flat	370	40-275	31.6	Round
6.10	10.76	14.40	14.40	8.98	—	Flat	370	40-275	31.6	Round
6.10	10.59	14.38	11.39	8.99	—	Flat	300	50-200	25.4	Round
2.50	10.90	14.38	11.24	9.00	—	Flat	392	25-340	34	Round
6.10	10.59	14.38	11.39	8.99	—	Round	320	50-250	—	Round
2.50	10.90	14.38	11.24	9.00	190	Flat	392	25-340	34	Round
2.49	11.86	14.23	11.33	8.99	—	Round	340	60-200	—	Round
2.50	10.90	14.24	11.35	9.00	—	Conical	340	100-250	—	Round

E	F	G	H	I						
Flange	Well depth	Left edge to A1 center	Top edge to A1 center	Well center to center	Bottom thickness (µm)	Well bottom shape	Total volume (µL)	Working volume (µL)	Growth Area (mm <sup>2</sup> )	Upper well shape
2.50	11.50	12.13	8.99	4.50	—	Flat	131	15-110	10	Rounded-square
2.50	11.50	12.13	8.99	4.50	190	Flat	131	15-110	10	Rounded-square

E	F	G	H	I						
Flange	Well depth	Left edge to A1 center	Top edge to A1 center	Well center to center	Bottom thickness (µm)	Well bottom shape	Total volume (µL)	Working volume (µL)	Growth Area (mm <sup>2</sup> )	Upper well shape
2.00	5.50	12.13	8.99	4.50	—	Flat	28	4-25	2.7	Rounded-square

E	F	G	H	I						
Flange	Well depth	Left edge to A1 center	Top edge to A1 center	Well center to center	Bottom thickness (µm)	Well bottom shape	Total volume (µL)	Working volume (µL)	Growth Area (mm <sup>2</sup> )	Upper well shape
E - 2.00 E <sup>1</sup> - 4.70	5.00	11.01	7.87	2.25	—	Flat	12.6	3-10	2.3	Rounded-square
E - 2.00 E <sup>1</sup> - 4.70	5.00	11.01	7.87	2.25	75	Flat	12.6	3-10	2.3	Rounded-square

E	F	G	H	I						
Flange	Well depth	Left edge to A1 center	Top edge to A1 center	Well center to center	Bottom thickness (µm)	Well bottom shape	Total volume (µL)	Working volume (µL)	Growth Area (mm <sup>2</sup> )	Upper well shape
E - 2.00 E <sup>1</sup> - 4.70	5.00	11.01	7.87	2.25	75	Flat	12.6	3-10	2.3	Rounded-square

384 Well Microplate

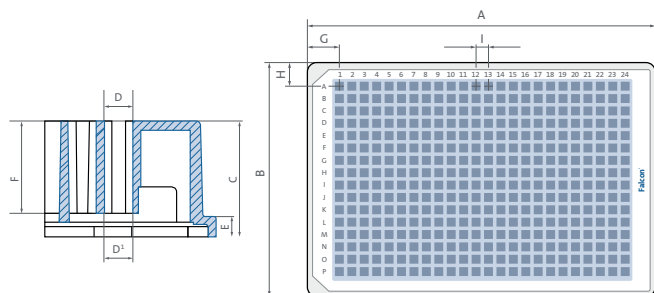

1536 Well Microplate

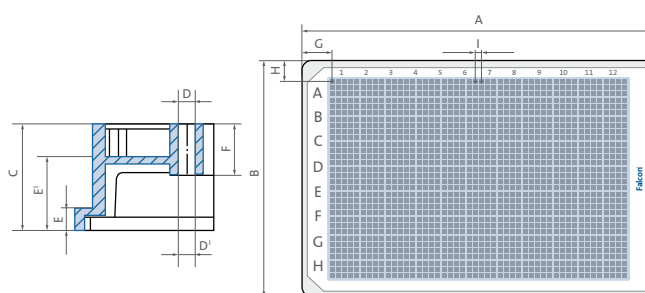

# Working Volumes for Tissue Culture Vessels

	Volume of Media (per item)	Volume of Trypsin* (per item)	Actual Growth Area (per item)
<b>Dishes</b>			
35 mm x 10 mm Style	2.5-3 mL	0.2-0.3 mL	11.78 cm <sup>2</sup>
60 mm x 15 mm Style	6-7 mL	0.5-0.6 mL	21.29 cm <sup>2</sup>
100 mm x 20 mm Style	16-17.5 mL	1 mL	58.95 cm <sup>2</sup>
150 mm x 25 mm Style	45-50 mL	1.5 mL	156.36 cm <sup>2</sup>
<b>Multiwell and Assay Plates</b>			
6 well plate	2.5-3 mL	0.2-0.3 mL	9.6 cm <sup>2</sup>
12 well plate	1.5-2.2 mL	0.1-0.2 mL	3.8 cm <sup>2</sup>
24 well plate	0.8-1 mL	0.08-0.1 mL	2 cm <sup>2</sup>
48 well plate	0.5-0.8 mL	0.05-0.08 mL	0.75 cm <sup>2</sup>
96 well microplate	0.1-0.2 mL	0.1-0.2 mL	0.32 cm <sup>2</sup>
384 well microplate	15-110 µL		10 mm <sup>2</sup>
384 well microplate small volume	4-25 µL		2.7 mm <sup>2</sup>
1536 well microplate	3-10 µL		2.3 mm <sup>2</sup>
<b>Flasks</b>			
12.5 cm <sup>2</sup>	4-5 mL	0.25-0.40 mL	12.5 cm <sup>2</sup>
25 cm <sup>2</sup>	8-9 mL	0.50-0.80 mL	25 cm <sup>2</sup>
75 cm <sup>2</sup>	20-30 mL	1 mL	75 cm <sup>2</sup>
150 cm <sup>2</sup>	40-50 mL	2 mL	150 cm <sup>2</sup>
175 cm <sup>2</sup>	45-55 mL	2 mL	175 cm <sup>2</sup>
225 cm <sup>2</sup>	60-100 mL	4-5 mL	225 cm <sup>2</sup>
525 cm <sup>2</sup> (3-layer)	6-50 mL per layer	6 mL	525 cm <sup>2</sup>
875 cm <sup>2</sup> (5-layer)	6-50 mL per layer	10 mL	875 cm <sup>2</sup>

\*Your lab protocol may call for another proteolytic enzyme.

# Cell Record Worksheet

Copy this form and use it in your lab's documentation procedures.

**Characterization:**

Name \_\_\_\_\_ Abbreviation \_\_\_\_\_

Morphology \_\_\_\_\_

Origin \_\_\_\_\_

Source  Primary Culture \_\_\_\_\_ Date \_\_\_\_\_

ATCC \_\_\_\_\_ Passage \_\_\_\_\_ Date \_\_\_\_\_

Other \_\_\_\_\_ Passage \_\_\_\_\_ Date \_\_\_\_\_

Biosafety Level  Class I — no virus/no contamination; subprimate or normal primate origin

Class II — virus/mycoplasma; clinical material, primate cells of tumor origin

Class III — HIV preps/T-cell lines

**Proliferation:**

Population Doubling Time \_\_\_\_\_ hours

Fast (requires handling every 1-2 days)

Medium (requires handling every 3-4 days)

Slow (requires handling once per week)

Split Ratio \_\_\_\_\_:\_\_\_\_\_

Routine Seeding Density \_\_\_\_\_

**Handling:**

Viability (Cells not used beyond passage) \_\_\_\_\_

Cell Removal  Mechanical/Scraping

Enzymatic

Trypsin

Other \_\_\_\_\_

Cell Culture Vessels (brand/size) \_\_\_\_\_

Culture vessel surface  Non-TC-treated  TC-treated  Corning® Primaria™

Collagen I  Fibronectin  Laminin

Lot #  Corning Matrigel® Matrix  Other

**Media:**

	<b>Storage Location:</b>	
Type	<input type="checkbox"/> Refrigerator	<input type="checkbox"/> Freezer _____
Serum	%	<input type="checkbox"/> Fetal Bovine Serum (FBS)
Lot #		<input type="checkbox"/> Other _____ <input type="checkbox"/> _____ <input type="checkbox"/> _____
Additives/Supplements (include lot #s)		
(Applicable vitamins, growth factors, antibiotics, etc.)	<input type="checkbox"/>	_____ <input type="checkbox"/> _____
	<input type="checkbox"/>	_____ <input type="checkbox"/> _____
	<input type="checkbox"/>	_____ <input type="checkbox"/> _____
	<input type="checkbox"/>	_____ <input type="checkbox"/> _____







## Additional Falcon® Labware

### Table of Contents

<b>Bacteriological Petri Dishes</b> . . . . .	<b>44</b>
<b>Cell Strainers and Containers</b> . . . . .	<b>45</b>
<b>Library Storage Plates</b> . . . . .	<b>46</b>

### **An array of products for general laboratory use**

In addition to Falcon Cultureware, Corning also manufactures:

- ▶ A variety of dishes with durable construction for stable dish manipulation
- ▶ Cell strainers available in three nylon mesh pore sizes for optimal performance
- ▶ Containers that are sterile and disposable to provide secure samples
- ▶ Polypropylene plates for short- and long-term compound storage

These high-quality Falcon products deliver consistent, reliable results.

# Falcon® Bacteriological Petri Dishes

- ▶ Durable construction for stable dish manipulation
- ▶ Crystal-grade, virgin polystyrene for optical clarity
- ▶ Sterilized by gamma irradiation
- ▶ Dimensions listed (diameter x height)



## Falcon Bacteriological Petri Dishes Ordering Information

Cat. No.	Description	Actual Dimensions (mm)	Qty/ Pk	Qty/ Cs
<b>Easy-Grip Style</b>				
351008	35 mm x 10 mm	40.28 O.D. x 6.17	20	500
<b>Standard Style</b>				
351007	60 mm x 15 mm	54.81 O.D. x 13.26	20	500
351029	100 mm x 15 mm	87.91 O.D. x 13.72	20	500
351058	150 mm x 15 mm	142.37 O.D. x 17.15	10	100
<b>Tight-fit Lid Dish</b>				
351006	50 mm x 9 mm	50.25 O.D. x 8.26	20	500

### Tips

- ▶ When using automated filling systems, a heavier-weight dish (e.g., Cat. No. 351029, 100 mm dish) prevents equipment from jamming.

# Falcon® Cell Strainers and Containers



## Falcon Cell Strainers

- ▶ A faster and easier alternative to gauze filtration in procedures involving dissociation of cells from either clumps or primary tissues
- ▶ Consistently obtain a more uniform single-cell suspension
- ▶ Three nylon mesh pore sizes for optimal performance in a variety of applications
- ▶ Sterilized and conveniently accessible in individual packaging
- ▶ Extended lip on strainer enables aseptic handling with forceps
- ▶ Strainers are made of a strong nylon mesh with 40, 70, or 100 µm pores that are evenly spaced for consistent results
- ▶ Molded color-coded polypropylene frame with tab enables easy handling

### Features

- ▶ Sterilized by gamma irradiation
- ▶ Individually packaged

## Falcon Cell Strainers Ordering Information

Cat. No.	Description	Qty/Pk	Qty/Cs
<b>Falcon Cell Strainers</b>			
352340	40 µm/Blue	1	50
352350	70 µm/White	1	50
352360	100 µm/Yellow	1	50

### Tips

- ▶ A special sterile cell strainer assembly designed for cell sorting devices is listed on page 44. It contains a 35-micron nylon mesh strainer that is an integral part of the cap to a 5 mL polystyrene tube.

## Falcon Containers

- ▶ Sterile, disposable polypropylene containers provide secure sample containment
- ▶ Available in 4½ oz. (110 mL) and 8 oz. (220 mL) sizes both with and without matching lids
- ▶ Feature molded-in graduations for easy measurements
- ▶ Graduated in ounces and milliliters to provide convenient, single-use, timesaving containers for collection, transportation, and storage of a wide variety of specimens
- ▶ Inert and chemically resistant to commonly used laboratory reagents at room temperature

### Features

- ▶ Sterilized by gamma irradiation
- ▶ 4½ oz. graduations from ½ oz. to 4½ oz. in ¼ oz. increments and from 20 mL to 110 mL in 10 mL increments
- ▶ 8 oz. size graduated from ¼ oz. to 8 oz. in ¼ oz. increments and from 20 mL to 220 mL in 10 mL increments

## Falcon Containers Ordering Information

Cat. No.	Description	Qty/Pk	Qty/Cs
<b>Falcon Containers</b>			
354013	110 mL (4½ oz.) with Lid	1	100
354014	110 mL (4½ oz.) without Lid	20	500
354015	220 mL (8 oz.) with Lid	1	100
354020	220 mL (8 oz.) without Lid	20	500
354017	Lid for both sizes	20	500

## Related Products

- ▶ Falcon Round-Bottom Tube with Cell Strainer Cap . . . . . 56
- ▶ Falcon 50 mL Conical Tubes. . . . . 58

# Falcon® Library Storage Plates

- ▶ 96 well library storage plates with different well shapes
- ▶ Made from virgin polypropylene resin



Additional Falcon® Labware

## Falcon 96 well Polypropylene Library Storage Plates

The Falcon 96 well Polypropylene Library Storage Plate is convenient for compound storage

- ▶ Exceedingly rigid and flat plate for consistent automated handling
- ▶ Plate withstands repeated freeze-thaws down to -20°C
- ▶ Low retention polypropylene and round-well design give low residual volumes after pipetting (<0.1 µL)
- ▶ Raised well edges and flatness for heat or adhesive sealing
- ▶ In addition to the round-bottom Falcon 96 well Library Storage Plate, V-bottom formats are also available.

## Falcon Library Storage Plates Ordering Information

Cat. No.	Description	Total Volume (µL)	Well Shape	Sterile	Notch	Qty/Pk	Qty/Cs
<b>Falcon 96 well Polypropylene Library Storage Plates</b>							
351190	96 well Library Storage Plate	340	Round	No	H12	25	100
353263	96 well Library Storage Plate	340	V-bottom	No	A1-H1	25	100





# Falcon® Pipets and Pipet Controller

## Table of Contents

Serological Pipets . . . . .	48
Individually Wrapped Serological Pipets . . . . .	49
Bulk-Packaged Serological Pipets . . . . .	50
Aspirating Pipets. . . . .	51
Transfer Pipets . . . . .	52
Pipet Controller. . . . .	53
Replacement Parts. . . . .	53

### The perfect pipet in a perfect package

Falcon Pipets, first in quality and first in innovation, are manufactured at our ISO 9001-certified facility in a state-of-the-art, high-performance work environment. Dedicated product teams use advanced technologies and techniques, combined with rigorous quality control procedures to ensure the integrity of every pipet.

Each pipet component is made of the highest quality polystyrene resin. Process control and attention to detail guarantee the finest quality product. A critical volumetrics test verifies the accuracy of each pipet by measuring the delivered volume.

The final result is consistently high-quality pipets that provide precise and accurate liquid handling.

# Falcon® Serological Pipets

- ▶ Individually wrapped polystyrene pipets available in paper-plastic or all-plastic thermoform packaging
- ▶ Exceptionally crisp, dark, easy-to-read printed graduations
- ▶ Graduation alignment system brings graduations to view quickly
- ▶ Available in bulk packaging
- ▶ Color-coded pipets facilitate correct size selection



Falcon Serological Pipets range in size from 1 mL to 100 mL.

## Sterile pipet packaging

- ▶ Customer demand for a sterile product has shaped the design of all Falcon brand products, especially serological pipets and pipet packaging. In the thermoform packaging process, heavy-gauge plastic material is heated and drawn to form a pouch. The pipet is placed in the pouch, and the pouch is sealed. Depending on user preference, the top web may be either paper or our Corning® Advantage™ all-plastic material. This packaging ensures Falcon Pipets are delivered to you contamination-free.

## Corning Advantage Pipet packaging for customers who prefer an all-plastic pipet wrapper

The Corning Advantage all-plastic individual pipet package offers:

- ▶ Reduced static cling
- ▶ Easy opening options: peel-open and pop-through
- ▶ Low particulates
- ▶ Complete recyclability

## Falcon 100 mL pipet

- ▶ The Falcon 100 mL pipet has up to a 115 mL graduated capacity, with total holding capacity of 125 mL—the highest currently available. Its innovative, stepped design allows it to fit easily into most media bottles and tissue culture vessels.

## Falcon individually wrapped pipets

- ▶ Falcon individually wrapped pipets are available in two thermoformed package styles: the popular paper-plastic wrap and the Corning Advantage all-plastic wrap.
- ▶ Falcon 1 mL and 2 mL individually wrapped pipets are provided in convenient canister boxes to make transfer and storage easier. Falcon bulk packaged pipets come in sturdy polyethylene bags.

# Falcon® Individually Wrapped Serological Pipets

- ▶ Polystyrene, disposable pipets for tissue culture, bacteriological, and research applications
- ▶ Sterilized by gamma irradiation
- ▶ Noncytotoxic, nonpyrogenicity tested to less than 0.1 EU/mL
- ▶ Negative graduations for extra capacity
- ▶ Reverse graduations (except 1 mL)
- ▶ Color-coded package and markings for ease of identification
- ▶ Polyester plug to help prevent overfill
- ▶ Accurate +/- 2% at full volume (excluding 1 and 2 mL)

## Falcon Individually Wrapped Serological Pipets Ordering Information

Paper-Plastic Thermoform Cat. No.	Corning® Advantage™ All-Plastic Cat. No.	Size	Color	Increments	Overfill Capacity	Qty/Pk	Qty/Cs
357521	356521	1 mL	Yellow ●	1/100	0.4 mL	100	1000
357507	356507	2 mL	Green ●	1/100	0.8 mL	100	1000
357543	356543	5 mL	Blue ●	1/10	2.5 mL	50	200
357551	356551	10 mL	Red ●	1/10	3.0 mL	50	200
357525	356525	25 mL, Space Saver	Purple ●	0.25	7.0 mL	50	200
357535	356535	25 mL, Extended	Purple ●	0.50	11.0 mL	50	200
357550	356550	50 mL	Black ●	1.0	10.0 mL	25	100
—	357600	100 mL	Black ●	1.0	15.0 mL	5	50

# Falcon® Bulk-Packaged Serological Pipets

- ▶ Polystyrene, disposable pipets for tissue culture, bacteriological, and research applications
- ▶ Sterilized by gamma irradiation
- ▶ Noncytotoxic, nonpyrogenicity tested to less than 0.1 EU/mL
- ▶ Negative graduations for extra capacity
- ▶ Reverse graduations (except 1 mL)
- ▶ Color-coded package and markings for ease of identification
- ▶ Polyester plug to help prevent overfill
- ▶ Accurate +/- 2% at full volume (excluding 1 and 2 mL)



Falcon® Pipets and Pipet Controller

Convenient pipet graduation alignment system—exclusively from Corning.

## Graduation alignment system

The pipet graduation alignment system is a fast and simple way to bring graduations to your line of sight. Simply pop open or peel back the top of the pipet package and line up the pipetter before completely removing the pipet from its wrapping. When you remove the pipet from its package, the graduations should face you every time.

## Falcon Bulk-Packaged Serological Pipets Ordering Information

Paper-Plastic Thermoform Cat. No.	Size	Color	Increments	Overfill Capacity	Qty/Pk	Qty/Cs
357506	1 mL	Yellow <span style="color: yellow;">●</span>	1/100	0.4 mL	25	1000
357508	2 mL	Green <span style="color: green;">●</span>	1/100	0.8 mL	25	1000
357529	5 mL	Blue <span style="color: blue;">●</span>	1/10	2.5 mL	25	500
357530	10 mL	Red <span style="color: red;">●</span>	1/10	3.0 mL	25	500
357515	25 mL, Space Saver	Purple <span style="color: purple;">●</span>	0.25	7.0 mL	20	200

## Falcon® Aspirating Pipets

- ▶ Sterile, polystyrene, non-plugged, non-graduated pipets
- ▶ Safer alternative to glass Pasteur pipets
- ▶ Can be used for all vacuum-aspirating procedures
- ▶ Noncytotoxic, nonpyrogenic tested to less than 0.1 EU/mL
- ▶ Individually packaged in thermoformed paper-plastic wrap to ensure sterile presentation

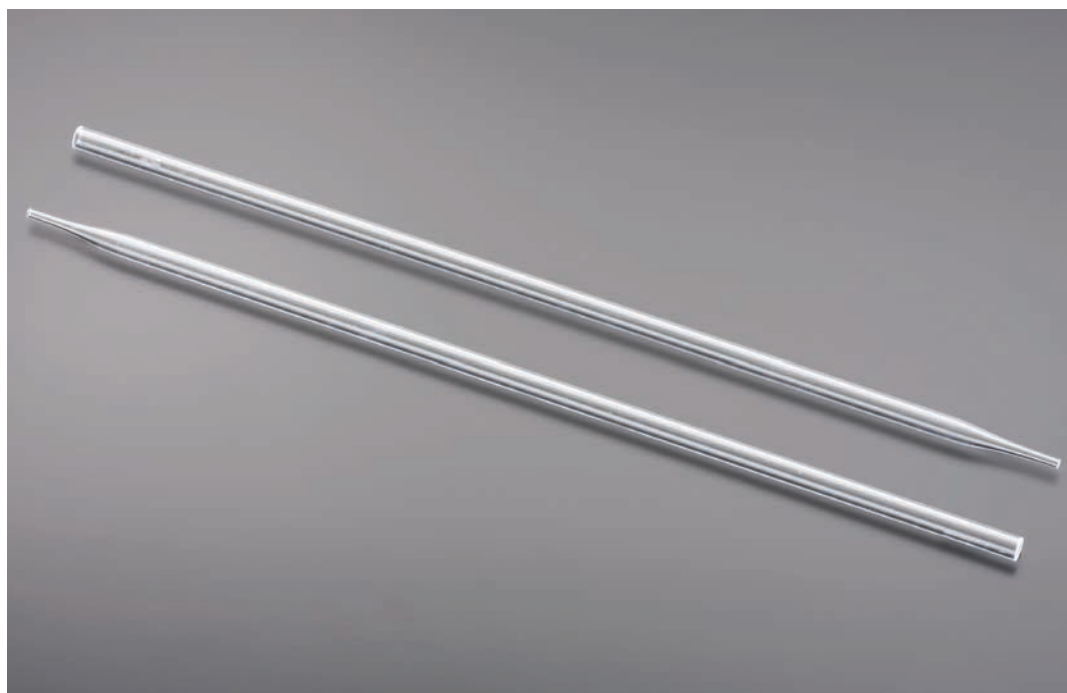

### Falcon Aspirating Pipets Ordering Information

Cat. No.	Size	Qty/Pk	Qty/Cs
<b>Falcon Aspirating Pipets</b>			
357558	2 mL	50	200
357501	5 mL	50	200



## Falcon® Transfer Pipets

- ▶ Highly durable, one-piece polyethylene design
- ▶ One squeeze draws 3 mL into this 6-inch transfer pipet
- ▶ Small tip ensures consistent reproduction of drop size
- ▶ Graduated at 1 mL and 2 mL marks



### Falcon Transfer Pipets Ordering Information

Cat. No.	Description	Qty/Pk	Qty/Cs
<b>Falcon Transfer Pipets</b>			
357575	Sterile	1	500
357524	Non-sterile	500	1000

# Falcon® Pipet Controller

- ▶ Ergonomic design for exceptional comfort
- ▶ LCD display for continuous visualization of speed, modes, and battery status
- ▶ Easy access to the battery compartment
- ▶ Easy maintenance



LCD display

Speed and mode control

Access to batteries

Nosepiece with autoclavable pipet holder and filter

Ergonomically positioned finger triggers provide comfortable grip

## Falcon Pipet Controller

The light, ergonomic, motorized pipet controller is designed for use with glass and plastic serological pipets from 0.5 to 100 mL volume ranges. Conveniently positioned switches change operating modes and speeds quickly to handle different liquid volumes and viscosities. Aspirating and dispensing speed is controlled through the finger triggers. When fully charged, the batteries enable up to 8 hours of continuous use. The large LCD display clearly indicates battery status, pipetting mode and speed.

The Falcon Pipet Controller is supplied with a two-position charging stand, a universal battery charger, and three batteries. Two 0.2 µm and two 0.45 µm hydrophobic polytetrafluoroethylene (PTFE) filters are supplied with the pipet controller. Additional filters are available as standard accessories. The filters, pipet holder, and nosepiece are autoclavable.

## Falcon Pipet Controller Ordering Information

Cat. No.	Description	Qty
<b>Falcon Pipet Controller</b>		
357469	Standard version with two 0.2 µm filters and two 0.45 µm filters, 2-position charging stand, universal power supply, and set of 3 batteries	1
357470	EUR version with two 0.2 µm filters and two 0.45 µm filters, 2-position charging stand, universal power supply and set of 3 batteries	1
357471	US version with two 0.2 µm filters and two 0.45 µm filters, 2-position charging stand, universal power supply and set of 3 batteries	1
<b>Falcon Pipet Controller Accessories</b>		
357472	Hydrophobic PTFE filter (0.2 µm), set of 5	1
357473	Hydrophobic PTFE filter (0.45 µm), set of 5	1
357474	Silicone pipet holder	1
357486	Battery (set of 3)	1



Two-position Charging Stand





# Falcon® Tubes

## Table of Contents

<b>Round-Bottom Tubes</b> . . . . .	<b>56</b>
<b>Conical Tubes</b> . . . . .	<b>58</b>
<b>Laboratory Aids</b> . . . . .	<b>60</b>
Tube Size Identification Chart . . . . .	60
Tube Chemical Resistance Chart . . . . .	61
Characteristics of Falcon Plasticware . . . . .	62
Rotor/Adapter Selection Guide . . . . .	64
Nomogram for Computing Relative Centrifugal Force . . . . .	65

### Test the sample, not the tube

Your life sciences research demands the most stable and controlled environment possible for the analysis of biological and chemical samples. At Corning Life Sciences, we manufacture our Falcon Conical and Round-Bottom Tubes from advanced bioanalytical-grade resins. Our polymer selection process includes extensive testing to ensure that the polymer does not leach unwanted substances and provides for low protein binding. Falcon Tubes and our unique medical-style packaging provide unsurpassed convenience and consistency.

## Falcon® Round-Bottom Tubes

- Widely used and referenced in laboratory protocols
- Dual position snap-cap prevents sample loss with ease of handling
- Sterile, nonpyrogenicity tested to less than 0.1 EU/mL



**Sterile tube with cell-strainer cap**  
Designed for flow cytometry applications, the 12 x 75 mm tube with cell strainer cap (Cat. No. 352235) offers a convenient way to prepare laboratory samples. A 35 µm nylon mesh is incorporated into the tube cap, which can be used to collect the dissociated sample for downstream processing in instruments.



**White graduations on 14 mL polypropylene tubes**  
Falcon brand 14 mL polypropylene tubes feature white printed graduations rather than traditional molded-in graduations. Easy-to-read markings and a solvent-resistant writing patch provide further convenience in use.

### The foundation for consistent research results

- Provide reliable containment of laboratory fluid samples
- Widely referenced in published procedures and protocols
- Polypropylene tubes are best suited for applications requiring greater thermal and chemical stability
- Polystyrene tubes are best suited for procedures requiring high optical clarity
- Dual-position snap caps, heavier gauge walls, and unique construction provide a secure, positive seal
- Medical-style packaging materials

### Tips

- Tubes with more consistent inner tolerance, such as the Falcon 5 mL round-bottom tubes, reduce maintenance and wear of the Bal Seal O Ring resulting in less down time and costly repairs of valuable instruments.



## Falcon Round-Bottom Tubes Ordering Information

### Polystyrene Round-Bottom Tubes

- 1400 RCF rating\*
- Tube dimensions and volumes are approximate

Cat. No.	Size (mm)	Volume (mL)	Cap	Qty/Pk	Qty/Cs
352003	12 x 75	5	Snap	1	500
352058	12 x 75	5	Snap	25	500
352054	12 x 75	5	Snap	125	1000
352052	12 x 75	5	None	125	1000
352008	12 x 75	5	None (nonsterile)	1000	1000
352235	12 x 75	5	Cell strainer, sterile	125	1000
352027	13 x 100	8	Screw	125	1000
352001	17 x 100	14	Snap	1	500
352057	17 x 100	14	Snap	25	500
352051	17 x 100	14	Snap	125	1000
352017	17 x 100	14	None	125	1000
352037	16 x 125	16	Screw	1	500
352025	16 x 125	16	Screw	125	1000
352045	16 x 150	19	Screw	1	500

\* RCF claims refer to Relative Centrifugal Force measured in g-force for materials with a specific gravity of 1.0, used in an appropriate rotor with correct cushion and safety precautions. Tubes used with organic solvents at temperatures below 0°C may have lower RCF ratings.

### Tips

- ▶ Racks for 15 mL Falcon Conical Tubes are also ideal for upright storage of Falcon 17 x 100 mm Round-Bottom Tubes.
- ▶ Expanded polystyrene racks are not recommended for storage below 0°C.

### High-clarity Polypropylene Round-Bottom Tubes

- 3000 RCF rating\*
- 17 x 100 mm tubes have printed graduations and white writing patch
- Tube dimensions and volumes are approximate

Cat. No.	Size (mm)	Volume (mL)	Cap	Qty/Pk	Qty/Cs
352063	12 x 75	5	Snap	25	500
352053	12 x 75	5	None	125	1000
352002	12 x 75	5	None (nonsterile)	100	1000
352006	17 x 100, printed	14	Snap	1	500
352059	17 x 100, printed	14	Snap	25	500
352018	17 x 100 printed	14	None	125	1000

### Polyethylene Snap Caps

- Dual position snap cap, offering vented as well as fully closed options
- Sterilized by gamma irradiation
- For use with both polystyrene and polypropylene tubes

Cat. No.	Description	Qty/Pk	Qty/Cs
352032	For 12 x 75 mm tubes	500	2000

### Related Products

- ▶ Falcon Conical Tubes . . . . . 58

## Falcon® Conical Tubes

- ▶ Meet bioanalytical-grade requirements and provide unsurpassed performance in critical research applications
- ▶ Exceptionally strong—Industry leading centrifugation rating of 16,000 RCF (50 mL polypropylene)
- ▶ Unique double threaded cap design reducing cross threading and leakage
- ▶ Easy-to-read graduations
- ▶ Consistent biological and physical properties
- ▶ Ideal for long-term cryogenic storage of specimens at -80°C (15 to 225 mL polypropylene tubes)



Falcon high-clarity conical tubes feature blue printing: dark blue graduations to help avoid eye strain, and a white writing patch that allows sample identification. For large fluid samples, use convenient 175 mL and 225 mL sizes. Made of durable polypropylene, these tubes allow for efficient large-scale laboratory centrifugation.

### The most dependable tube in the lab

Falcon Conical Tubes are easy-to-use, high-quality tools to protect your precious samples. State-of-the-art design and manufacturing create tubes engineered to provide high strength, wide temperature stability, and to perform in your critical applications. They will protect your valuable samples during centrifugation, vortexing, and long term storage in the freezer. To meet this intense challenge, Falcon tubes are designed for:

- ▶ High strength: State-of-the-art mold design, coupled with advanced resin selection, create tube walls that are engineered to perform under high-stress situations.
- ▶ Nonpyrogenicity: Tested to less than 0.1 EU/mL.
- ▶ Nontoxicity: Resins are selected via an intense array of U.S. Pharmacopoeia (USP) toxicity tests.
- ▶ Low protein binding: Corning engineers and scientists are continually searching for materials and processes that minimize labware-induced interference, such as protein binding.
- ▶ Quality packaging: Falcon Tubes, in addition to offering bioanalytical-grade performance, use medical-style packaging to better assure sterile presentation. The conical tubes are packaged in convenient reusable racks or compact environmentally-friendly bulk packs.

## Falcon Conical Tubes Ordering Information

### 15 mL Capacity Tubes

- Approximate dimensions: 17 mm O.D.; 120 mm length
- Sterilized by gamma irradiation, noncytotoxic and nonpyrogenic
- Dark blue printed graduations and white writing patch
- Polyethylene dome-seal screw cap offers positive seal over full circumference
- Rack can be separated into two sections

Cat. No.	Description	RCF Rating*	Qty/Pk	Qty/Cs
352196	15 mL/High Clarity Polypropylene, with free empty rack	12000	50	500
352096	15 mL/High Clarity Polypropylene	12000	50	500
352097	15 mL/High Clarity Polypropylene, in rack	12000	50	500
352095	15 mL/Polystyrene	1800	50	500
352099	15 mL/Polystyrene, in rack	1800	50	500

### 50 mL Capacity Tubes

- Approximate dimensions: 30 mm O.D.; 115 mm length
- Sterilized by gamma irradiation, noncytotoxic and nonpyrogenic
- Dark blue printed graduations and white writing patch
- Polyethylene flat-top screw cap allows one hand manipulation and provides a level writing area

Cat. No.	Description	RCF Rating*	Qty/Pk	Qty/Cs
352070	50 mL/High Clarity Polypropylene	16000	25	500
352098	50 mL/High Clarity Polypropylene, in rack	16000	25	500
358206	Screw caps for 50 mL tubes	—	50	1000

### 175 mL and 225 mL Capacity Tubes

- 175 mL capacity: approximate dimensions are 61 mm O.D.; 118 mm length
- 225 mL capacity: approximate dimensions are 61 mm O.D.; 137 mm length
- Sterilized by gamma irradiation
- Molded graduations
- Polyethylene plug-seal screw cap

Cat. No.	Description	RCF Rating*	Qty/Pk	Qty/Cs
352076	175 mL/Polypropylene	7500	8	48
352075	225 mL/Polypropylene	7500	8	48

### Accessories for 175 mL and 225 mL Capacity Tubes

Cat. No.	Description	Qty/Cs
352090	Cushions and extractor for Cat. Nos. 352076, 352075, nonsterile	8

\* RCF claims refer to Relative Centrifugal Force measured in g-force for materials with a specific gravity of 1.0, used in an appropriate rotor with correct cushion and safety precautions. Tubes used with organic solvents at temperatures below 0°C may have lower RCF ratings.



The 50 mL conical tubes are available in either bulk- or rack-packaged configurations. For the convenience of oriented, sterile product presentation, choose the recyclable, expanded polystyrene foam rack option. For applications that do not require the convenience of tubes in racks, choose the bulk-package option with 40% less packaging material.

### Tips



- ▶ When marking tubes, black ink Sharpie® pens are the most resistant to alcohol. Other colors tend to smudge.
- ▶ Racks for 15 and 50 mL Falcon Conical Tubes are ideal for upright storage.
- ▶ Expanded polystyrene racks are not recommended for storage below 0°C.

### Related Products

- ▶ Falcon Cell Strainers . . . . . 45
- ▶ Falcon Round-Bottom Tubes . . . . . 56

# Falcon® Tube Size Identification Chart

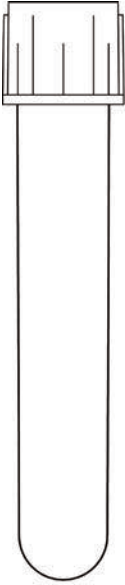
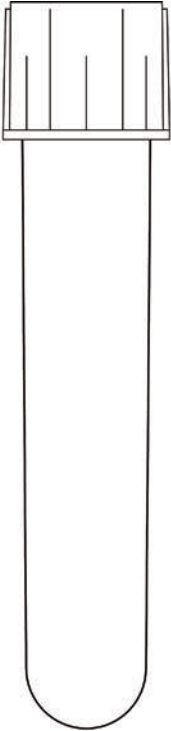
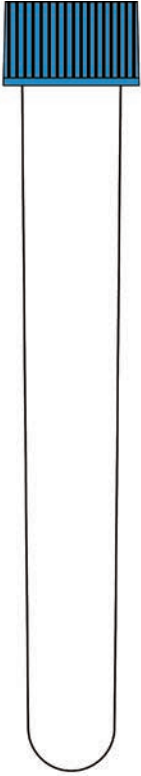
For accurate reordering, compare your tube to these actual-size drawings

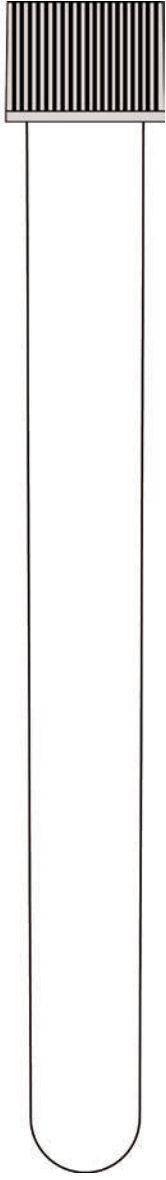
5 mL 12 mm x 75 mm Snap Cap	14 mL 17 mm x 100 mm Snap Cap	8 mL 13 mm x 100 mm Screw Cap	16 mL 16 mm x 125 mm Screw Cap	19mL 16 mm x 150 mm Screw Cap
				
<p><b>Polystyrene</b></p> <p>Cat. No. 352003 352008 352052 352054 352058 352235</p> <p><b>Polypropylene</b></p> <p>Cat. No. 352002 352053 352063</p>	<p><b>Polystyrene</b></p> <p>Cat. No. 352001 352017 352051 352057</p> <p><b>Polypropylene</b></p> <p>Cat. No. 352006 352018 352059</p>	<p><b>Polystyrene</b></p> <p>Cat. No. 352027</p>	<p><b>Polystyrene</b></p> <p>Cat. No. 352025 352037</p>	<p><b>Polystyrene</b></p> <p>Cat. No. 352045</p>

Falcon® Tubes

# Falcon® Tube Chemical Resistance Chart

	Polypropylene		Polystyrene	
	Room Temp.	50-60°C	Room Temp.	50-60°C
Acetaldehyde	■ ■	X	X	X
Acetic Acid, 5%	■ ■ ■	■ ■ ■	■ ■ ■	■ ■
Acetic Acid, 50%	■ ■ ■	■ ■ ■	■ ■	■ ■
Acetone	■ ■ ■	■ ■ ■	X	X
Acetonitrile	■	X	X	X
Ammonium Acetate, Saturated	■ ■ ■	■ ■ ■	■ ■ ■	■ ■ ■
Ammonium Hydroxide, 5%	■ ■ ■	■ ■ ■	■ ■ ■	■
Ammonium Hydroxide, 30%	■ ■ ■	■ ■	■ ■	■
n-Butyl Alcohol	■ ■ ■	■ ■ ■	■ ■ ■	■ ■
Chloroform	X	X	X	X
Chromic Acid, 50%	■ ■	■	■	■
Cyclohexane	■	X	X	X
Dimethylsulfoxide	■ ■ ■	■ ■ ■	■ ■ ■	■ ■
Ether	X	X	X	X
Ethyl Alcohol, 50%	■ ■ ■	■ ■	■ ■	■
Ethyl Alcohol, Absolute	■ ■ ■	■ ■	■	X
Ethylene Glycol	■ ■ ■	■ ■ ■	■ ■ ■	■ ■ ■
Formaldehyde, 10%	■ ■ ■	■ ■ ■	■	X
Formaldehyde, 40%	■ ■ ■	■ ■	X	X
Formic Acid, 5%	■ ■ ■	■ ■	■ ■ ■	■ ■
Formic Acid, 50%	■ ■ ■	■ ■	■	■
Glutaraldehyde	■ ■ ■	■ ■ ■	■ ■ ■	■
Glycerine	■ ■ ■	■ ■ ■	■ ■ ■	■ ■ ■
Glycerol	■ ■ ■	■ ■ ■	■ ■ ■	■ ■ ■
Hydrochloric Acid, 1-5%	■ ■ ■	■ ■ ■	■ ■ ■	■ ■ ■
Hydrochloric Acid, 35%	■ ■ ■	■ ■	■	■
Hydrogen Peroxide, 5%	■ ■ ■	■ ■ ■	■ ■ ■	■ ■
Hydrogen Peroxide, 30%	■ ■ ■	■ ■	■ ■ ■	■ ■
Isobutanol	■ ■ ■	■ ■ ■	■ ■	■ ■
Isopropanol	■ ■ ■	■ ■ ■	■ ■ ■	■ ■
Methyl Alcohol Methanol	■ ■ ■	■ ■ ■	■	X
Methyl Ethyl Ketone	■ ■ ■	■ ■	X	X
Nitric Acid, 1-10%	■ ■ ■	■ ■ ■	■ ■	X
Nitric Acid, 70%	X	X	X	X
Phenol, Liquid	X	X	X	X
Phosphoric Acid, 1-5%	■ ■ ■	■ ■ ■	■ ■ ■	■ ■ ■
Phosphoric Acid, 85%	■ ■ ■	■ ■	■ ■ ■	■ ■
Picric Acid	X	X	■ ■	■
Pine Oil	■ ■ ■	■ ■	X	X
Potassium Hydroxide, 1%	■ ■ ■	■ ■ ■	■ ■	■ ■
Potassium Hydroxide, Concentrated	■ ■ ■	■ ■ ■	■ ■	■ ■
Sodium Hydroxide, 50% to Saturated	■ ■ ■	■ ■ ■	■ ■ ■	■ ■ ■
Sulfuric Acid, 10%	■ ■ ■	■ ■	■ ■ ■	■ ■
Sulfuric Acid, 98% Concentrated	■	X	X	X
Trichloroacetic Acid	■	X	■	X
Tris Buffer, Solution	■ ■ ■	■ ■	■ ■	X

## Compatibility with chemical:

- ■ ■ Excellent
- ■ Good
- Fair
- X Not Recommended for continual use



# Characteristics of Falcon® Plasticware

Material	Properties (Re: Lab Use)	Clarity	Autoclave Results	Heat Distortion Point	Burning Rate
Polystyrene (Styrene)	Biologically inert, hard, excellent optical qualities	Clear	Melts	147-175°F 64-80°C	Slow
High-Impact Polystyrene	Rubber content gives improved strength to styrene	Opaque	Melts	147-195°F 64-90°C	Slow
Styrene Acrylonitrile	Improved strength over polystyrene	Clear	Melts	195-200°F 90-93°C	Slow
Polyethylene (High-Density)	Biologically inert, high chemical resistance	Opaque	Withstands several cycles	250°F 121°C	Slow
Polyethylene (Low-Density)	Biologically inert, high chemical resistance	Opaque	Melts	105-120°F 40-49°C	Slow
Polypropylene	Biologically inert, high chemical resistance, exceptional toughness	Translucent	Withstands several cycles	250°F 121°C	Slow
Polycarbonate	Clear, very tough, inert, high temperature resistance	Clear	OK	280-290°F 138-143°C	Self-extinguishing
Methyl, Methacrylate (Plexiglass, Lucite)	Finest optical qualities, easily fabricated	Clear	Melts	160-190°F 71-88°C	Slow
Cellulose Acetate (Acetate)	Clear, tough, somewhat flexible	Clear	Melts	110-194°F 43-90°C	Slow
Nylon	Tough, heat resistant, machineable, high moisture vapor transmission	Opaque	OK	300-356°F 150-180°C	Self-extinguishing
P.T.F.E.	Biologically and chemically inert, high heat resistant, slippery surface	Opaque	OK	250°F 121°C	None
P.V.C. (Plasticized)	Inert, tough, clear, high chemical resistance	Clear	Melts	110-175°F 43-80°C	Self-extinguishing
Vinyl-Chloride (Goen, Saran)	Clear, popular as film material	Clear	Melts	130-150°F 54-66°C	Self-extinguishing
Cellulose Nitrate (Celluloid)	Tough, fairly clear	Clear	Melts	140-160°F 60-71°C	Fast (explosive)
Polypropylene Film	Clear film material	Clear	OK	260°F 126°C	Slow
Thermosetting Polyester Films (Mylar)	Clear film material	Clear	OK	258°F 121°C	Self-extinguishing

The following are Tradenames: Plexiglass (Rohm & Hass Co.), Lucite & Mylar (E.I. duPont & Co.), Geon (B. F. Goodrich Chem. Co.), Celluloid (Mazzucchelli Celluloide S.p.A.).

Portions of this table courtesy of Modern Plastics Encyclopedia. Most data are from tests by ASTM methods. Tables show averages or ranges. Many properties vary with manufacturer, formulation, and testing laboratory.

\*Obtained from a table that lists gas permeability in cc/100 sq. in. per 24 hrs/mil.

Effect of Laboratory Reagents (Routine Storage or Contact Periods)					Gas Permeability of Thin-Wall Products*		
Weak Acids	Strong Acids	Weak Alkalies	Strong Alkalies	Organic Solvents	O <sub>2</sub>	N <sub>2</sub>	CO
None	Oxidizing acids attack	None	None	Soluble in aromatic chlorinated hydrocarbons	Low	Very low	High
None	Oxidizing acids attack	None	None	Soluble in aromatic chlorinated hydrocarbons	—	—	—
None	Oxidizing acids attack	None	None	Soluble-ketones, esters, and chlorinated hydrocarbons	Very low	Very low	Low
None	Oxidizing acids attack	None	None	Resistant below 80°C	High	Low	Very high
None	Oxidizing acids attack	None	None	Resistant below 60°C	High	Low	Very high
None	Oxidizing acids attack	None	None	Resistant below 175°C	High	Low	Very high
None	None	None	Slowly attacked	Soluble in chlorinated hydrocarbons—part soluble in aromatics	Very low	Very low	Low
Slight	Oxidizing acids attack	Slight	Slight	Soluble in ketones, esters, aromatic hydrocarbons	Very high	Very low	—
Slight	Decomposes	Slight	Decomposes	Softens in alcohol, Soluble in ketones, esters	Very low	Very low	High
None	Attacked	None	None	Resistant	Very low	Very low	—
None	None	None	None	Resistant	—	—	—
None	None	None	None	Soluble in ketones, esters	Low	—	High
None	None	None	None	Slightly resistant to hydrocarbons, ketones, etc.	Low	—	High
Slight	Decomposes	Slight	Decomposes	Soluble in ketones and esters, softens in alcohol, slightly affected by hydrocarbons	—	—	—
None	Oxidizing acids attack	None	None	Resistant below 175°C	High	Low	Very high
None	None	None	None	Good to excellent	Very low	Very low	Very low

Falcon® Tubes

# Rotor/Adapter Selection Guide

Centrifuge	Rotor Name	Rotor Type*	Adapter for Falcon® 15 mL Conical Tube	Adapter for Falcon 50 mL Conical Tube
<b>Beckman Coulter, Inc.</b>				
GS-15/R	S4180	SW	361230	361234
	C0650	FA	—	Dedicated 50 mL rotor
	C1015	FA	Dedicated 15 mL rotor	—
TJ-6/R	TH-4	SW	339276 359487, aerosol, set of 2 358991, aerosol, set of 4	339273 359488, aerosol, set of 2 358992, aerosol, set of 4
GS-6/R/K/KR	GH-3.8	SW	359151, set of 4 359472, set of 2 359487, aerosol, set of 2 358991, aerosol, set of 4	359154, set of 4 359475, set of 2 359488, aerosol, set of 2 358992, aerosol, set of 4
Avanti 30	C0650	FA	—	Dedicated 50 mL rotor
	C1015	FA	Dedicated 15 mL rotor	—
J6 Large Cap.	JS-3.0, JS-4.0, JS-4.2, JS-5.2	SW	359151, set of 4 359472, set of 2	345386
J2 Series or Avanti J-25 3-place	JS-7.5	SW	356964, 4-place adapter	356966, 1-place adapter 362213 (set of buckets),
	JS-4.3	SW	359151, set of 4 359472, set of 2 359487, aerosol, set of 2 358991, aerosol, set of 4 356960, 4-place adapter	359154, set of 4 359475, set of 2 359488, aerosol, set of 2 358992, aerosol, set of 4 356965, 1-place adapter Dedicated 50 mL rotor
	JA-10, JLA-10.500	FA	—	Dedicated 50 mL rotor
	JA-12	FA	—	Dedicated 50 mL rotor
	JA-14	FA	356964, 4-place adapter	356966, 1-place adapter
	JA-18	FA	356962, 1 tube per adapter	356963, 1 tube per adapter
<b>Sorvall, Inc.</b>				
TC-6	H-400	SW	78033	78035
GLC-2B/3 or RC-3	M	FA	03667	—
	SP/X	FA	00363	None required
	HL-4 w/omnicarrier	SW	00565	00648
	HL-4 w/carrier 00624	SW	—	00630
	HL-4 w/carrier 00634	SW	00363	—
RT-6000B/D or T-6000B/D	A-384	FA	None required	—
	A-500	FA	00363	None required
	A/S-400	FA	11148	None required
	H-1000B	SW	00884 or 11018 with 11152	00438 or 11148 with 11152
RT-7 places	RTH-250	SW	00884 or 11018 with 11152	00438 or 11148 with 11152
	RTH-750	SW	00447	00436-3 places or 00445-5
	SL-50T	FA	00402	—
RC-3B/C or RC-3B/C Plus places	LA/S-400	FA	11148	None required
	H-2000B	SW	00884 or 11018 with 11152	00438 or 11148 with 11152
	HG-4L, H-4000, H-6000A	SW	00892	00436-3 places or 00445-5
Super T-21 places	SL-50T, SL-50RT	FA	00402	—
	SL-250T	FA	00456	03072
	STH-750	SW	00447	00436-3 places or 00445-5
RC-5B/C or RC-5BC/Plus or RC-24 or RC-26 places	GSA, SLA-1000, SLA-1500	FA	00456	03072
	SLA-600TC	FA	74232	None required
	GS-3, SLA-3000	FA	00456 and 00614	00614 and 03072
	SH-3000	SW	00447	00436-3 places or 00445-5
	HS-4 w/carrier 00479	SW	00456	03072
	HS-4 w/carrier 00481	SW	None required	None required
HS-4 w/carrier 00480	SW	—	00363	
RC-28S	SL-250T	FA	00456	03072
	F-16/250	FA	00456	03072

\* SW: Swinging bucket; FA: Fixed angle

# Nomogram for Computing Relative Centrifugal Force

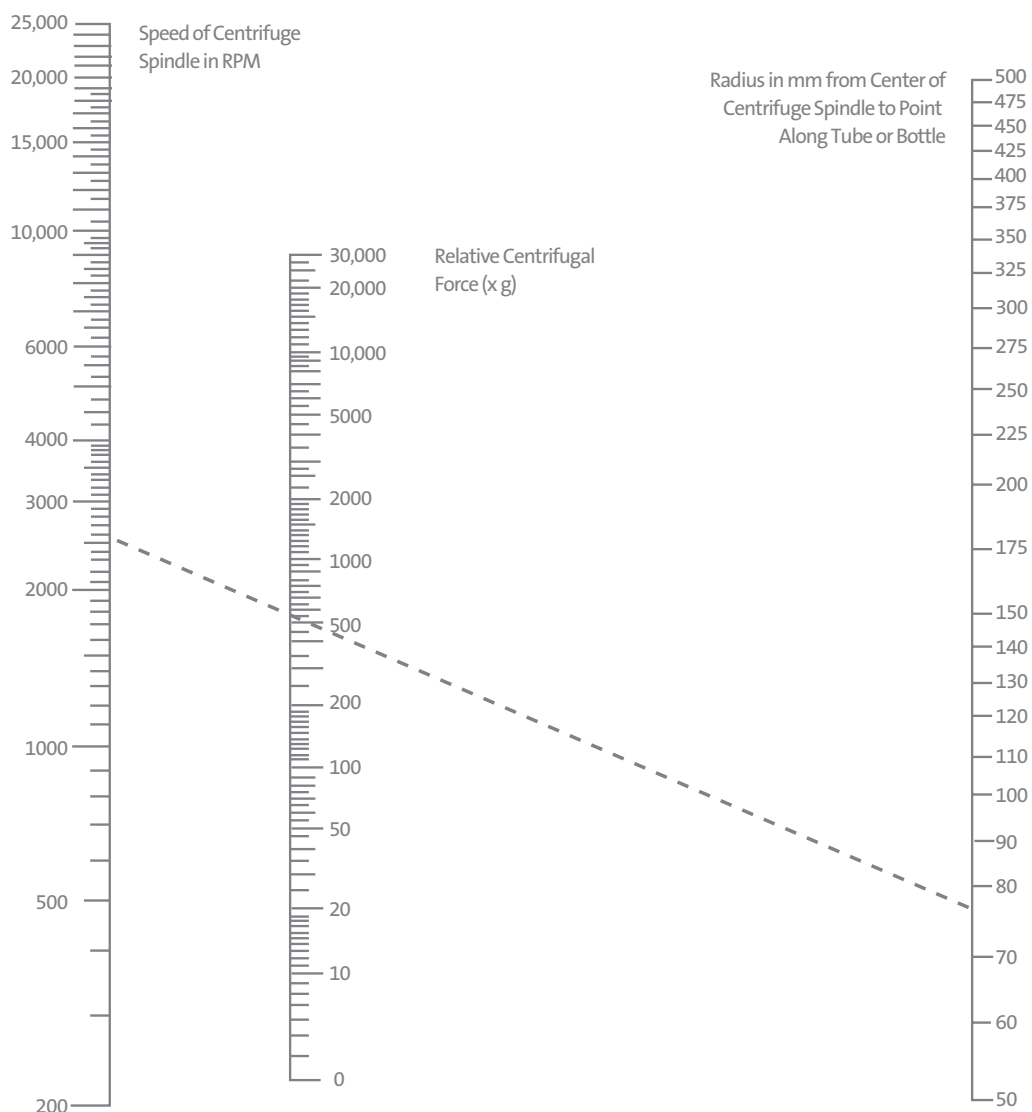

Falcon® Tubes

To calculate the RCF value at any point along the tube or bottle, measure the radius, in mm, from the center of the centrifuge spindle to the particular point. Draw a line from the radius value on the right-hand column to the appropriate centrifuge speed on the left-hand column. The RCF value is the point where the line crosses the center column. The nomogram is based on the formula:

$$RCF = (11/17 \times 10^{-7}) RN^2$$

where:

R = Radius in mm from centrifuge spindle to point in tube bottom

N = Speed of spindle in RPM

# Catalog Number Index

Cat. No.	Page No.	Cat. No.	Page No.	Cat. No.	Page No.
351006	44	352025	.57, 60	353043	.17
351007	44	352027	.57, 60	353046	.17
351008	44	352032	57	353047	17, 29, 35
351029	44	352037	.57, 60	353072	.17, 38
351058	44	352045	.57, 60	353075	.17, 38
351130	31	352051	.57, 60	353077	.17, 38
351131	31	352052	.57, 60	353078	.17
351143	17	352053	.57, 60	353082	9
351146	17	352054	.57, 60	353085	.19
351147	17, 29, 35	352057	.57, 60	353086	.19
351151	33	352058	.57, 60	353087	.19
351152	33	352059	.57, 60	353089	.19
351155	35	352063	.57, 60	353090	.26
351156	35	352070	.59	353091	.26
351157	35	352075	.59	353092	.26
351158	35	352076	.59	353093	.26
351161	37	352090	.59	353095	.26
351162	37	352095	.59	353096	.26
351163	37	352096	.59	353097	.26
351164	37	352097	.59	353102	.26
351172	.17, 38	352098	.59	353103	.26
351177	.17, 38	352099	.59	353104	.26
351178	17	352196	.59	353107	9
351180	29	352235	.57, 60	353108	9
351181	29	352340	.45	353109	9
351182	29	352350	.45	353110	9
351183	29	352360	.45	353112	9
351184	29	353001	.15	353118	9
351185	29	353002	.15	353133	9
351186	.29, 35	353003	.15	353135	9
351190	.38, 46	353004	.15	353136	9
352001	.57, 60	353009	9	353138	9
352002	.57, 60	353014	9	353139	9
352003	.57, 60	353018	9	353143	.9, 11
352006	.57, 60	353024	9	353144	.9, 11
352008	.57, 60	353025	.15	353180	.26
352017	.57, 60	353028	9	353181	.26
352018	.57, 60	353037	.15	353182	.26



<u>Cat. No.</u>	<u>Page No.</u>	<u>Cat. No.</u>	<u>Page No.</u>	<u>Cat. No.</u>	<u>Page No.</u>
353219 . . . . .	17, 38	353836 . . . . .	.18	356550 . . . . .	.49
353224 . . . . .	.17	353846 . . . . .	.17, 23	356551 . . . . .	.49
353225 . . . . .	.17	353847 . . . . .	17, 23, 29, 35	357469 . . . . .	.53
353226 . . . . .	17, 29, 35	353872 . . . . .	.17, 23	357470 . . . . .	.53
353227 . . . . .	.17, 38	353910 . . . . .	.17, 38	357471 . . . . .	.53
353230 . . . . .	.17	353916 . . . . .	.17, 38	357472 . . . . .	.53
353263 . . . . .	.38, 46	353924 . . . . .	.31	357473 . . . . .	.53
353292 . . . . .	.26	353925 . . . . .	.31	357474 . . . . .	.53
353296 . . . . .	.17, 38	353928 . . . . .	.37	357486 . . . . .	.53
353376 . . . . .	.17, 38	353934 . . . . .	.17	357501 . . . . .	.51
353377 . . . . .	.17, 38	353935 . . . . .	17, 29, 35	357506 . . . . .	.50
353378 . . . . .	.18, 38	353936 . . . . .	.17, 38	357507 . . . . .	.49
353379 . . . . .	.18, 38	353938 . . . . .	.31	357508 . . . . .	.50
353380 . . . . .	.18, 38	353958 . . . . .	.18	357515 . . . . .	.50
353381 . . . . .	.18, 38	353961 . . . . .	.18, 38	357521 . . . . .	.49
353382 . . . . .	.18, 38	353962 . . . . .	.18, 38	357524 . . . . .	.52
353383 . . . . .	.18, 38	353963 . . . . .	.18, 38	357525 . . . . .	.49
353384 . . . . .	.18, 38	353988 . . . . .	.18, 38	357529 . . . . .	.50
353385 . . . . .	.18, 38	354013 . . . . .	.45	357530 . . . . .	.50
353386 . . . . .	.18, 38	354014 . . . . .	.45	357535 . . . . .	.49
353492 . . . . .	.26	354015 . . . . .	.45	357543 . . . . .	.49
353493 . . . . .	.26	354017 . . . . .	.45	357550 . . . . .	.49
353494 . . . . .	.26	354020 . . . . .	.45	357551 . . . . .	.49
353495 . . . . .	.26	354104 . . . . .	.13	357558 . . . . .	.51
353502 . . . . .	.27	354108 . . . . .	.13	357560 . . . . .	.53
353503 . . . . .	.27	354114 . . . . .	.13	357564 . . . . .	.53
353504 . . . . .	.27, 33	354118 . . . . .	.13	357567 . . . . .	.53
353652 . . . . .	.21	354637 . . . . .	.12	357568 . . . . .	.53
353653 . . . . .	.21	354638 . . . . .	.12	357569 . . . . .	.53
353654 . . . . .	.21	354639 . . . . .	.12	357572 . . . . .	.53
353655 . . . . .	.21	355000 . . . . .	9	357575 . . . . .	.52
353801 . . . . .	.15, 23	355001 . . . . .	9	357578 . . . . .	.53
353802 . . . . .	.15, 23	355467 . . . . .	.27	357579 . . . . .	.53
353803 . . . . .	.15, 23	356507 . . . . .	.49	357582 . . . . .	.53
353808 . . . . .	.9, 23	356521 . . . . .	.49	357592 . . . . .	.53
353810 . . . . .	.9, 23	356525 . . . . .	.49	357593 . . . . .	.53
353813 . . . . .	.9, 23	356535 . . . . .	.49	357600 . . . . .	.49
353824 . . . . .	.9, 23	356543 . . . . .	.49	358206 . . . . .	.59





**Warranty/Disclaimer:** Unless otherwise specified, all products are for research use only. Not intended for use in diagnostic or therapeutic procedures. Corning Life Sciences makes no claims regarding the performance of these products for clinical or diagnostic applications.

Falcon *In Vitro* Fertilization plasticware is CE marked in compliance with the European Medical Devices Directive 93/42/EEC. Falcon IVF plasticware cleared as US Class II medical devices by the FDA per 21 CFR 884.

**Corning acquired the Advantage™, BioCoat™, Express™, Falcon®, FluoroBlok™, Matrigel®, and Primaria™ brands.**

For additional product or technical information, please visit [www.corning.com/lifesciences](http://www.corning.com/lifesciences). You can contact our Scientific Support Team at [ScientificSupportEMEA@corning.com](mailto:ScientificSupportEMEA@corning.com).

## official distributor

SZABO-SCANDIC HandelsgmbH  
Quellenstraße 110, A-1100 Wien  
T. +43(0)1 489 3961-0  
F. +43(0)1 489 3961-7  
[mail@szabo-scandic.com](mailto:mail@szabo-scandic.com)  
[www.szabo-scandic.com](http://www.szabo-scandic.com)



SZABO  
SCANDIC

### Corning Incorporated Life Sciences Europe

Corning BV  
Fogostraat 12  
1060 LJ Amsterdam  
The Netherlands  
Phone: +31 (0) 20 659 60 51  
Fax: +31 (0) 20 659 76 73  
[cceurnl@corning.com](mailto:cceurnl@corning.com)  
[www.corning.com/lifesciences](http://www.corning.com/lifesciences)

### Support Offices

#### EUROPE

**France**  
t 0800 916 882  
f 0800 918 636

**Germany**  
t 0800 101 1153  
f 0800 101 2427

**The Netherlands**  
t 31 20 655 79 28  
f 31 20 659 76 73

**United Kingdom**  
t 0800 376 8660  
f 0800 279 1117

**All Other European  
Countries**  
t 31 (0) 20 659 60 51  
f 31 (0) 20 659 76 73

CORNING

FALCON®

AXYGEN®

GOSELIN™